

SPINAL PRODUCT CATALOG

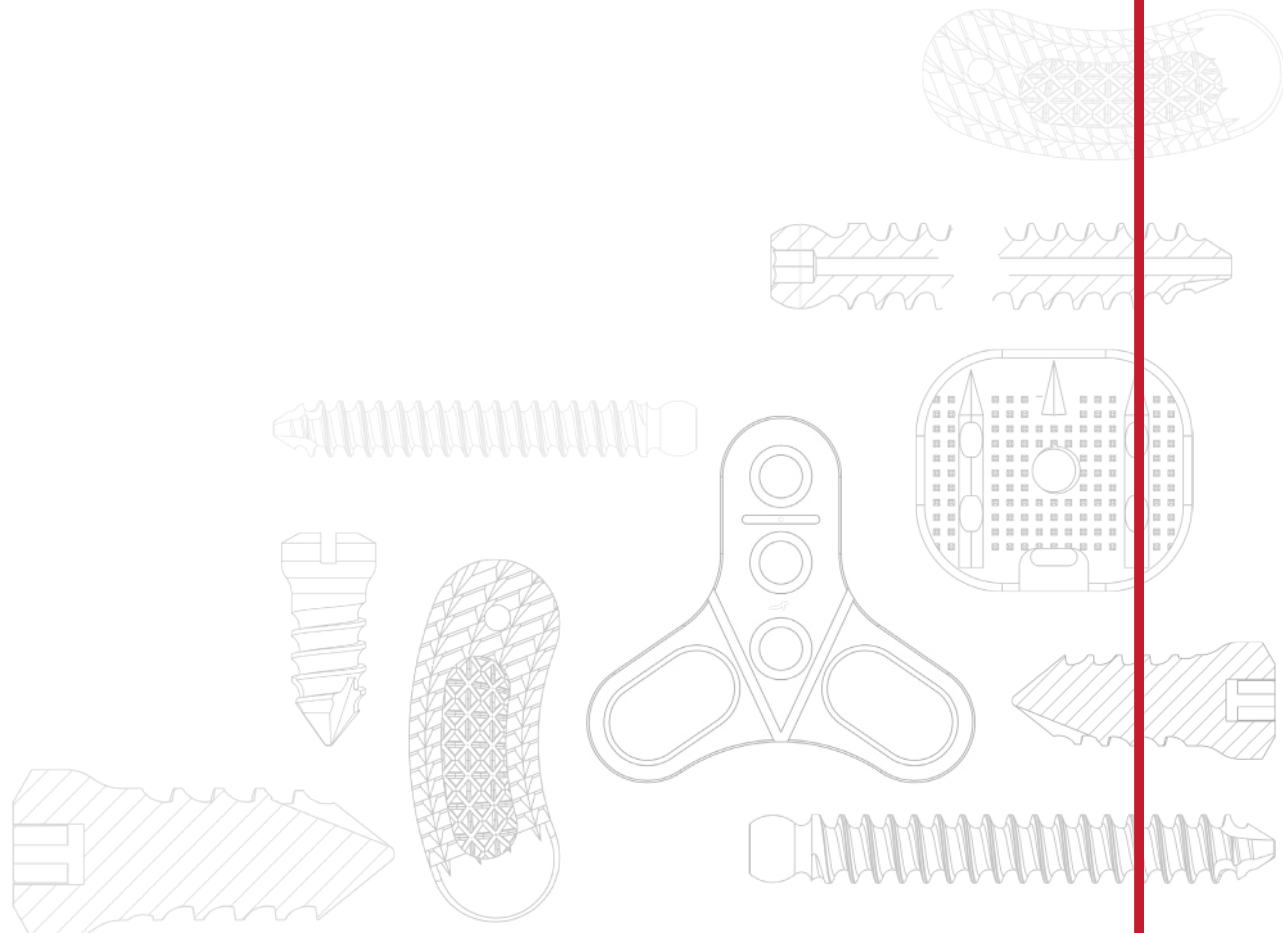

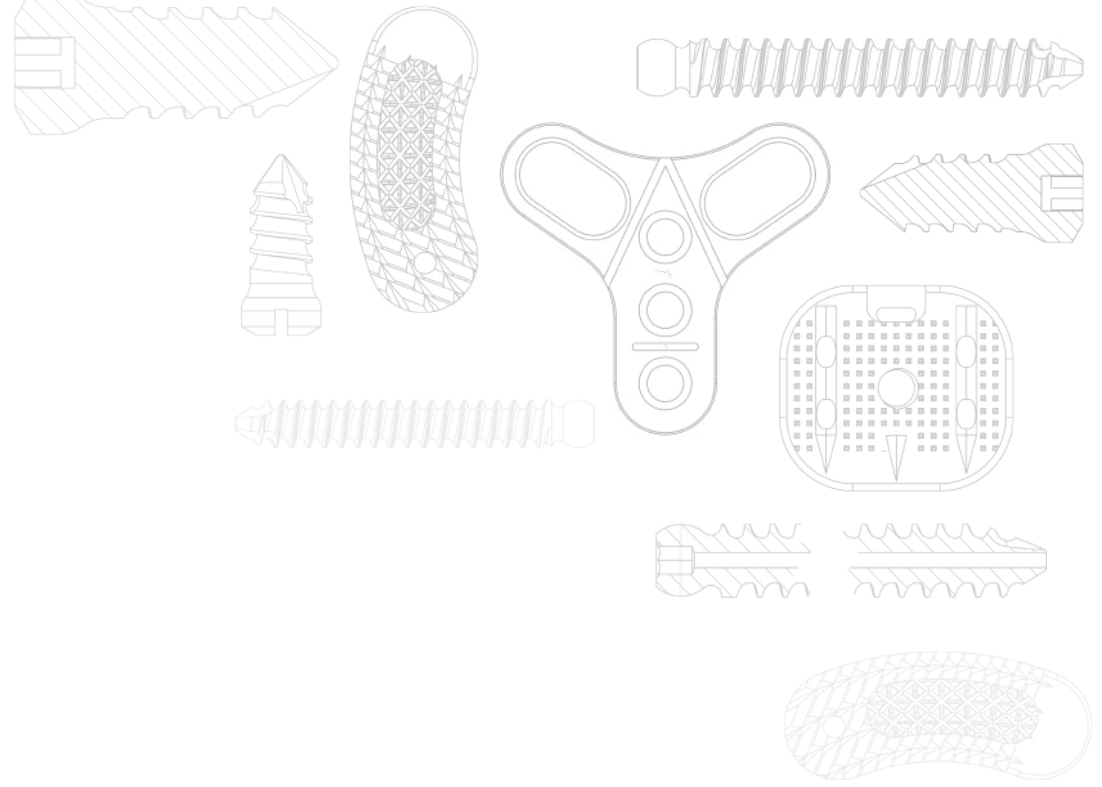

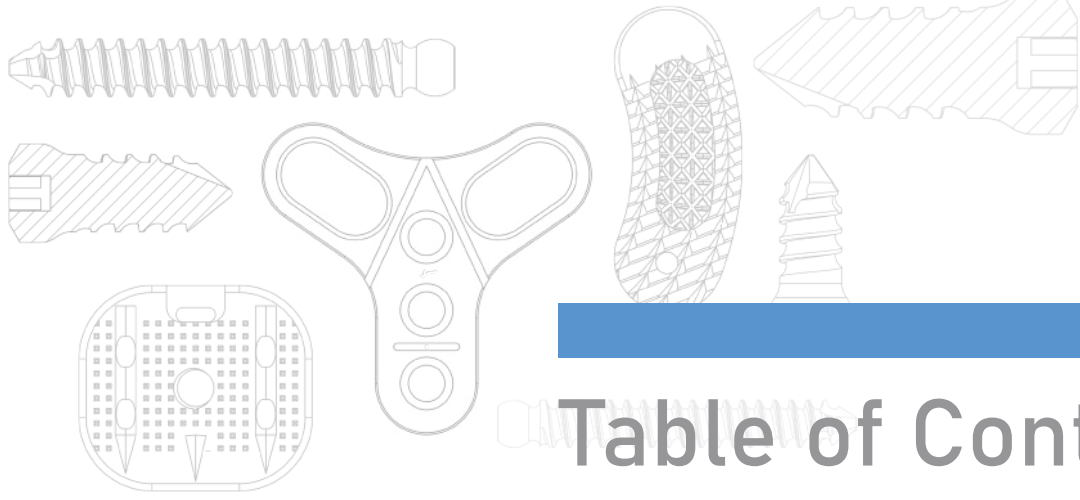

Table of Contents

5-46

Implant Types

47-56

Instrument Sets

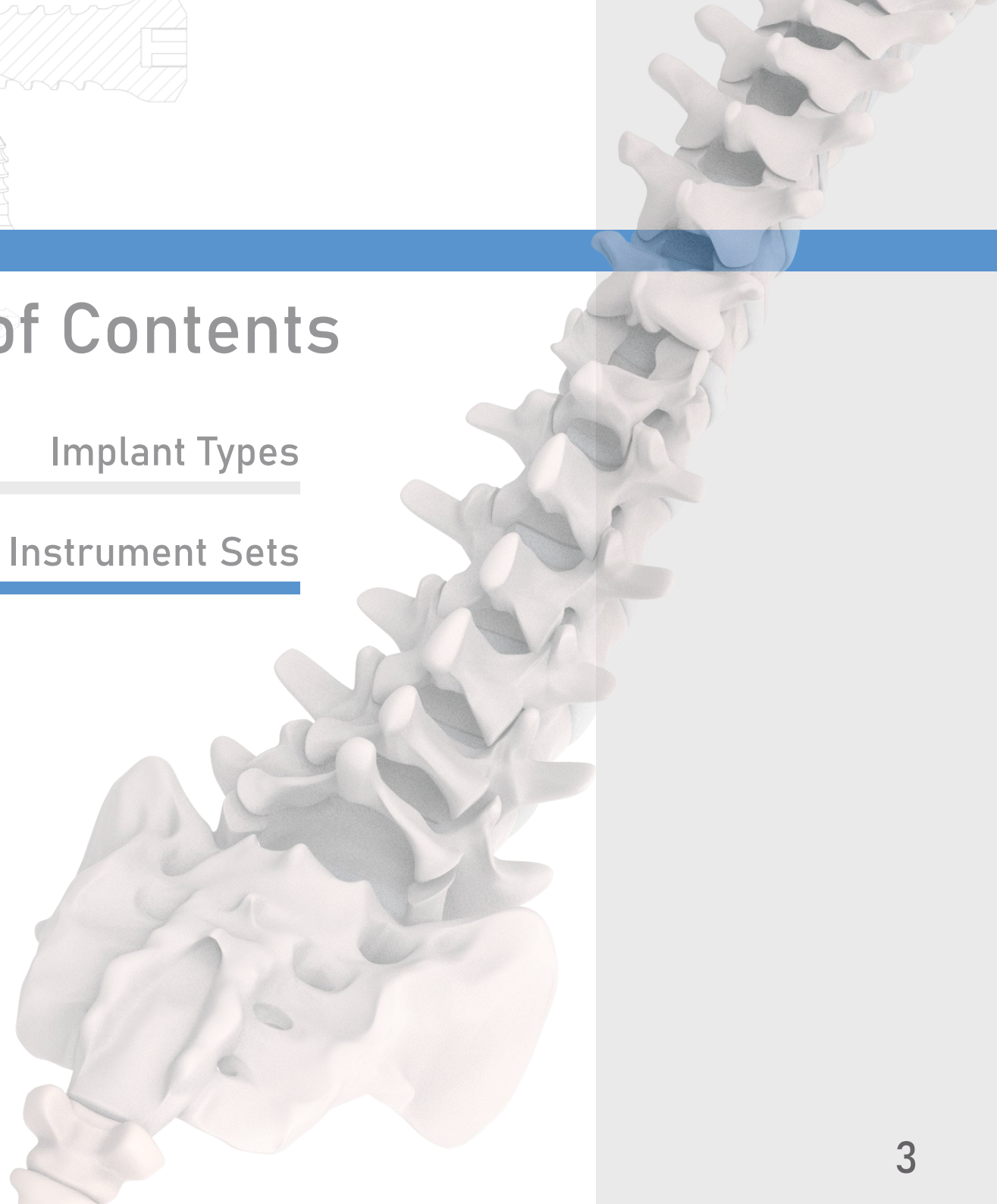

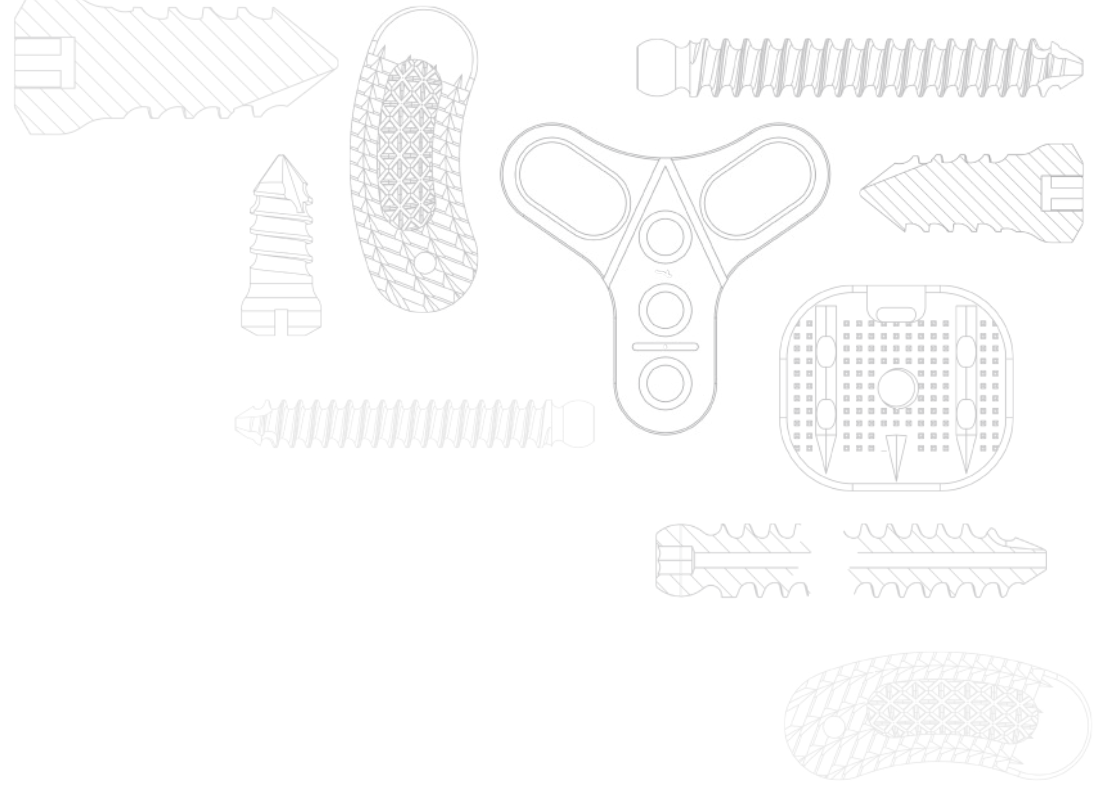

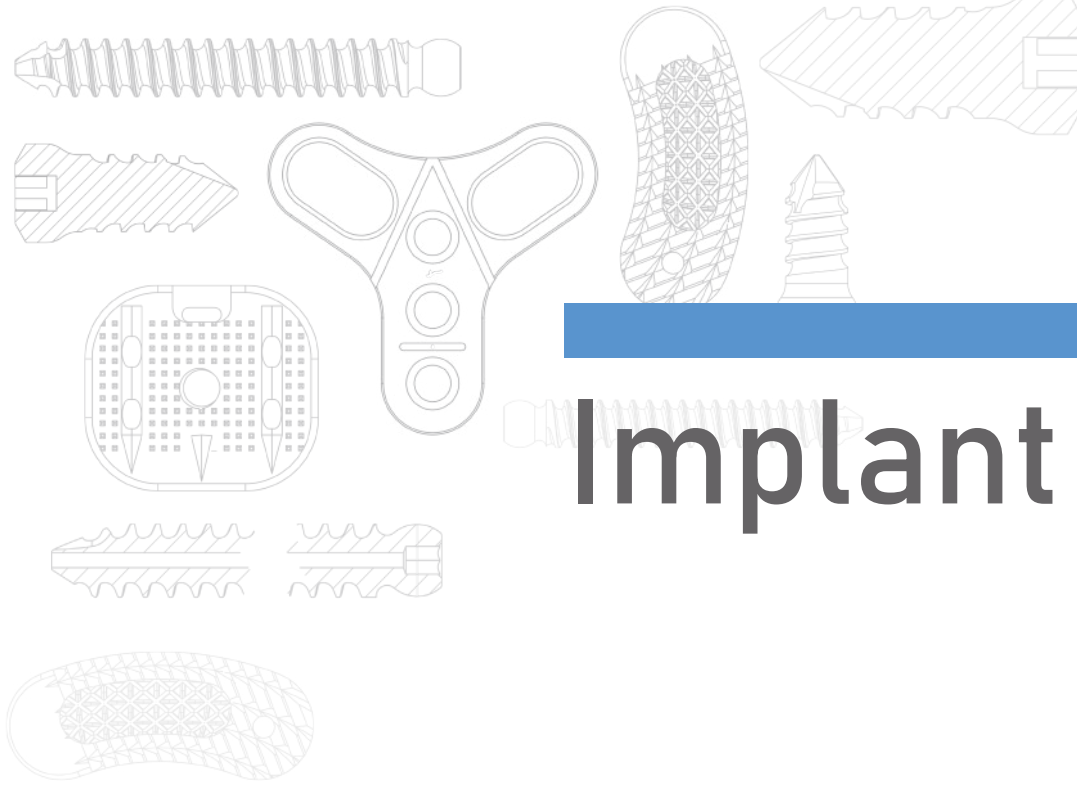

Implant Types



POLAR

Cervical Peek Cage



This implant system used with Polar and Polar-B Cervical Peek Cage Instrument Set
(Set Code: N-SS-013)

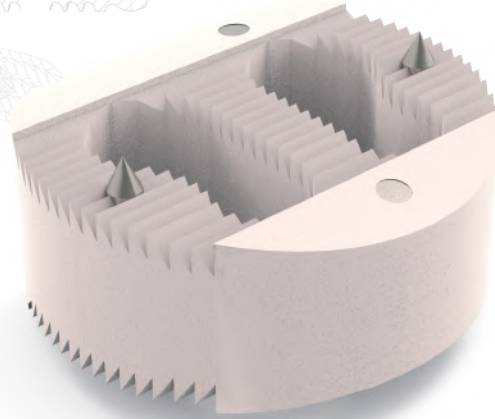
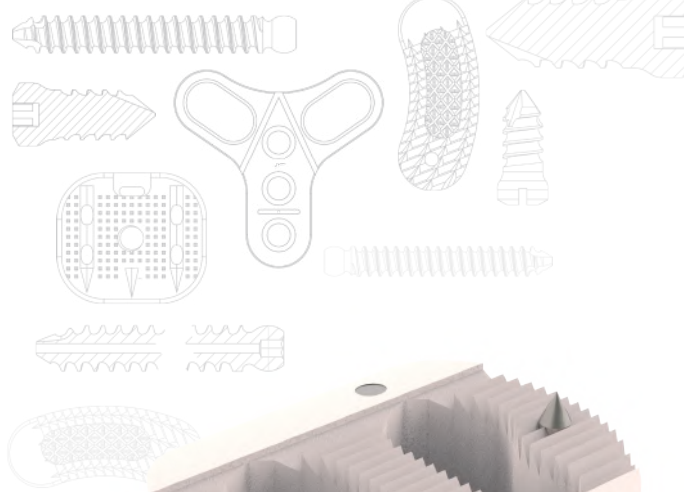
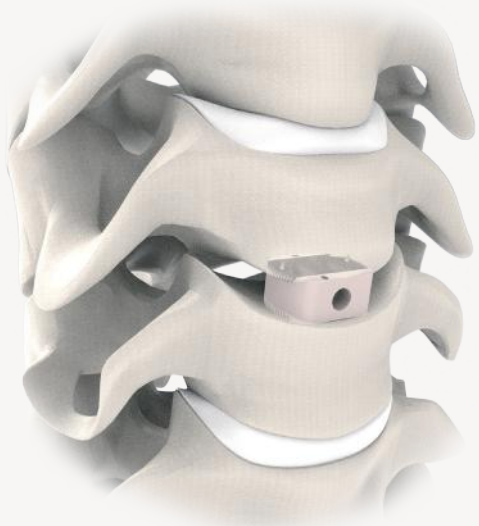

Polar Cervical Peek Cage

Product Code H(mm) L(mm) W(mm) Piece

NCPC041214	4	12	14	
NCPC041216	4	12	16	
NCPC041414	4	14	14	
NCPC041416	4	14	16	
NCPC051214	5	12	14	
NCPC051216	5	12	16	
NCPC051414	5	14	14	
NCPC051416	5	14	16	
NCPC061214	6	12	14	
NCPC061216	6	12	16	
NCPC061414	6	14	14	
NCPC061416	6	14	16	
NCPC071214	7	12	14	
NCPC071216	7	12	16	
NCPC071414	7	14	14	
NCPC071416	7	14	16	
NCPC081214	8	12	14	
NCPC081216	8	12	16	
NCPC081414	8	14	14	
NCPC081416	8	14	16	

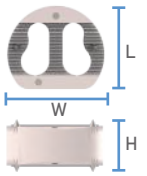

H: Height(mm), L: Length(mm), W: Width(mm)

Features;

- Not lesion persistent that produced by peek material compatible with MR
- Best fit with anatomic structure
- Tantalum marker
- Strong fixation by superior and inferior area with threaded surface and two titanium pins

POLAR-B

Cervical Bladed Peek Cage



This implant system used with Polar and Polar-B Cervical Peek Cage Instrument Set
(Set Code: N-SS-013)

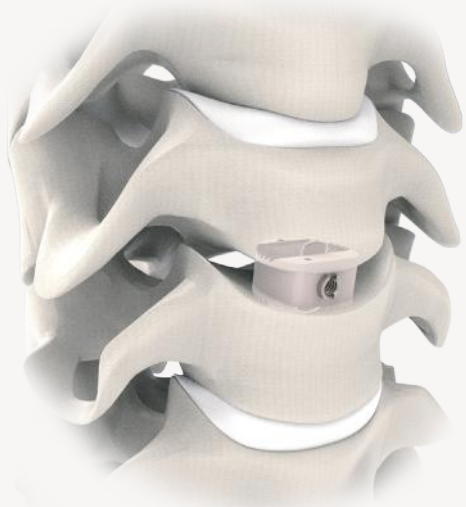

Bladed fixation

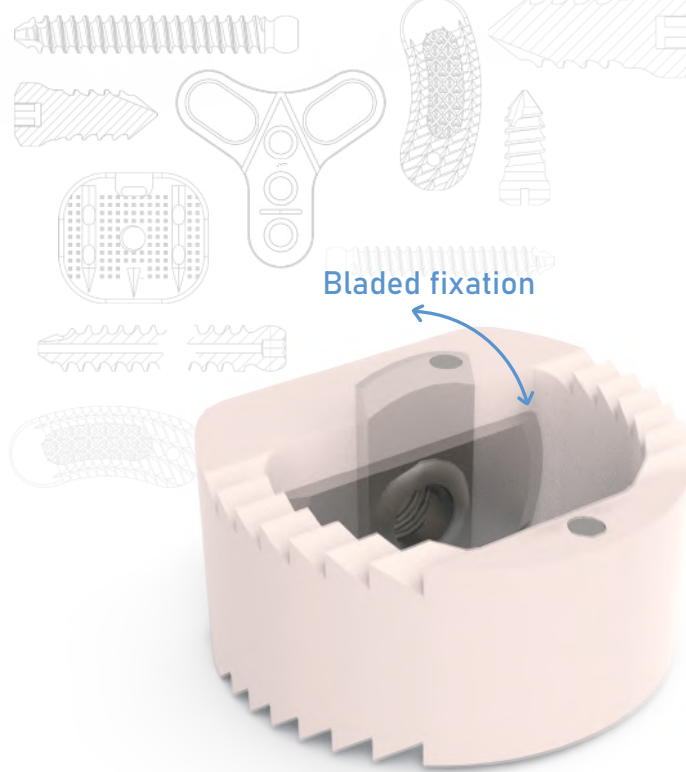

Polar-B Cervical Bladed Peek Cage

Product Code	H(mm)	L(mm)	W(mm)	Piece
NCPCB41214	4	12	14	
NCPCB41216	4	12	16	
NCPCB41414	4	14	14	
NCPCB41416	4	14	16	
NCPCB51214	5	12	14	
NCPCB51216	5	12	16	
NCPCB51414	5	14	14	
NCPCB51416	5	14	16	
NCPCB61214	6	12	14	
NCPCB61216	6	12	16	
NCPCB61414	6	14	14	
NCPCB61416	6	14	16	
NCPCB71214	7	12	14	
NCPCB71216	7	12	16	
NCPCB71414	7	14	14	
NCPCB71416	7	14	16	
NCPCB81214	8	12	14	
NCPCB81216	8	12	16	
NCPCB81414	8	14	14	
NCPCB81416	8	14	16	

Product Code	H(mm)	L(mm)	W(mm)	Piece
NCPCB41214	4	12	14	
NCPCB41216	4	12	16	
NCPCB41414	4	14	14	
NCPCB41416	4	14	16	
NCPCB51214	5	12	14	
NCPCB51216	5	12	16	
NCPCB51414	5	14	14	
NCPCB51416	5	14	16	
NCPCB61214	6	12	14	
NCPCB61216	6	12	16	
NCPCB61414	6	14	14	
NCPCB61416	6	14	16	
NCPCB71214	7	12	14	
NCPCB71216	7	12	16	
NCPCB71414	7	14	14	
NCPCB71416	7	14	16	
NCPCB81214	8	12	14	
NCPCB81216	8	12	16	
NCPCB81414	8	14	14	
NCPCB81416	8	14	16	

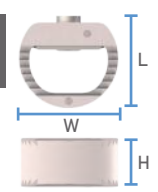

H: Height(mm), L: Length(mm), W: Width(mm)

Features;

- Locking blade mechanism
- Tantalum marker
- Threaded surface
- Large graft area

Tra-Ti Trabecular Cervical Cage



This implant system used with Polar and Polar-B Cervical Peek Cage Instrument Set
(Set Code: N-SS-013)

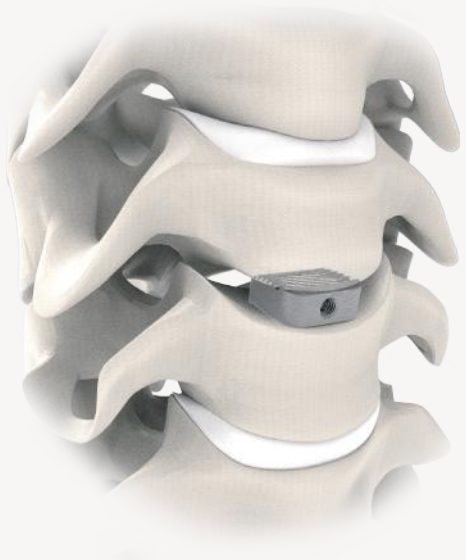

Tra-Ti Trabecular Cervical Cage

Product Code H(mm) L(mm) W(mm) Piece

N-TTC041214	4	12	14	
N-TTC041216	4	12	16	
N-TTC041414	4	14	14	
N-TTC041416	4	14	16	
N-TTC051214	5	12	14	
N-TTC051216	5	12	16	
N-TTC051414	5	14	14	
N-TTC051416	5	14	16	
N-TTC061214	6	12	14	
N-TTC061216	6	12	16	
N-TTC061414	6	14	14	
N-TTC061416	6	14	16	
N-TTC071214	7	12	14	
N-TTC071216	7	12	16	
N-TTC071414	7	14	14	
N-TTC071416	7	14	16	
N-TTC081214	8	12	14	
N-TTC081216	8	12	16	
N-TTC081414	8	14	14	
N-TTC081416	8	14	16	

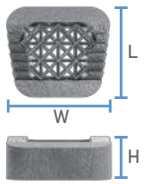

H: Height(mm), L: Length(mm), W: Width(mm)

Features;

- 3D printed metal technology
- Best fit with anatomic structure
- Best fusion

TRIMI

Anterior Cervical Plate System



This implant system used with Trimi Anterior Cervical Plate Instrument Set
(Set Code: N-SS-024)



Trimi Anterior Cervical Plate System

Product Code	Hole	L(mm)	T(mm)	Piece
NCAP17	4	17	2	
NCAP20	4	20	2	
NCAP25	4	25	2	
NCAP30	4	30	2	
NCAP33	6	33	2	
NCAP36	6	36	2	
NCAP45	6	45	2	
NCAP50	6	50	2	
NCAP60	8	60	2	
NCAP70	8	70	2	
NCAP80	10	80	2.1	
NCAP90	10	90	2.1	



Cervical Anterior Plate Screw

Product Code	D(mm)	L(mm)	Piece
NCAPS12	3.5	12	
NCAPS14	3.5	14	
NCAPS16	3.5	16	
NCAPS18	3.5	18	
NCAPS20	3.5	20	



Cervical Anterior Plate Screw Revision

Product Code	D(mm)	L(mm)	Piece
NCAPSR12	4.0	12	
NCAPSR14	4.0	14	
NCAPSR16	4.0	16	
NCAPSR18	4.0	18	
NCAPSR20	4.0	20	



D: Diameter(mm), L: Length(mm), T: Thickness(mm)

Features;

- Provide high strength with low thickness
- Provide effective and simple use
- Low profile (totally 2 mm)
- Flexible blocking system securely to the screw

VERTELIFT-C

Anterior Cervical Corpectomy Cage



This implant system used with Vertelift-C Corpectomy Cage Instrument Set
(Set Code: N-SS-006)

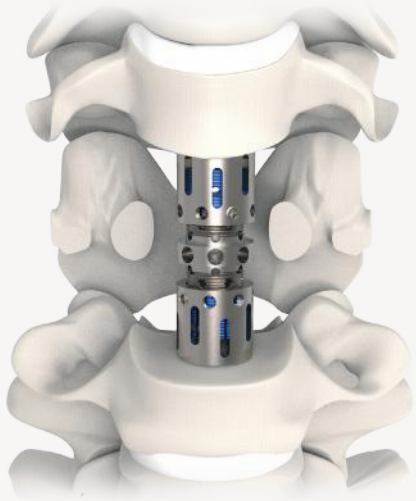

Vertelift-C Corpectomy Cage

Product Code D(mm) CL(mm) OL(mm) Angle Piece

NCTC101013	10	10	13	-	
NCTC101317	10	13	17	-	
NCTC101625	10	16	25	-	
NCTC121013	12	10	13	-	
NCTC121317	12	13	17	-	
NCTC121625	12	16	25	-	
NCTC1216256	12	16	25	6°	
NCTC122440	12	24	40	-	
NCTC1224406	12	24	40	6°	
NCTC123965	12	39	65	-	
NCTC1239656	12	39	65	6°	
NCTC141013	14	10	13	-	
NCTC141317	14	13	17	-	
NCTC141625	14	16	25	-	
NCTC1416256	14	16	25	6°	
NCTC142440	14	24	40	-	
NCTC1424406	14	24	40	6°	
NCTC143965	14	39	65	-	
NCTC1439656	14	39	65	6°	
NCTC161013	16	10	13	-	
NCTC161317	16	13	17	-	
NCTC161625	16	16	25	-	
NCTC162440	16	24	40	-	
NCTC163965	16	39	65	-	
NCTC201013	20	10	13	-	
NCTC201317	20	13	17	-	
NCTC201625	20	16	25	-	



D: Diameter(mm), CL: Closed Length(mm), OL: Opened Length(mm)

Features;

- Allowing a complete contact with vertebral surface
- Provide a secure fixation with the feature of threaded surface
- Efficient grafting space before distraction
- Provide one stage locking mechanism

Z-RHYTHM

Laminoplasty Plate System



This implant system used with Laminoplasty Plate Instrument Set
(Set Code: N-SS-019)

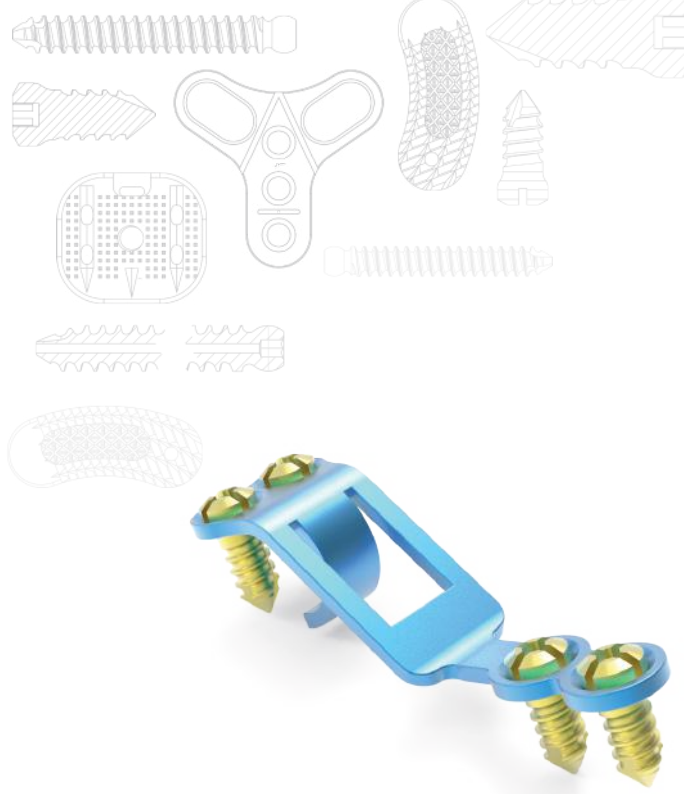

Z-Rhythm Laminoplasty Plate System			
Product Code	T(mm)	L(mm)	Piece
NLPXS	1	10	
NLPS	1	11	
NLPM	1	12	
NLPL	1	13	
NLPXL	1	14	

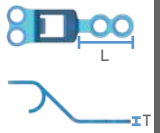

Laminoplasty Self Drilling Screw			
Product Code	D(mm)	L(mm)	Piece
NLPS5	2.0	5	
NLPS6	2.0	6	
NLPS7	2.0	7	
NLPS8	2.0	8	

Laminoplasty Rescue Screw			
Product Code	D(mm)	L(mm)	Piece
NLPRS5	2.4	5	
NLPRS6	2.4	6	
NLPRS7	2.4	7	
NLPRS8	2.4	8	

D: Diameter(mm), L: Length(mm), T: Thickness(mm)

Features;

- Increase canal space
- Easy-release screwdriver
- Tab allows for secure positioning on the lamina
- 5 plate sizes and two types of screw (Self drilling and rescue screw)

OXIS PLUS

Occipitocervical Fixation System



This implant system used with Oxis-PLUS Instrument Set

(Set Code: N-SS-005)

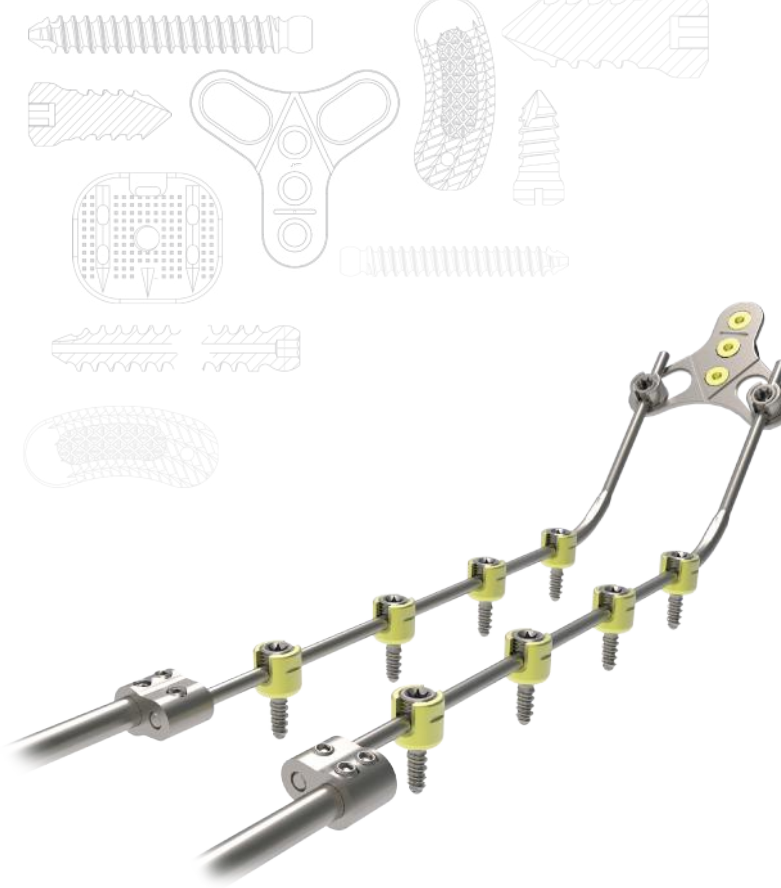
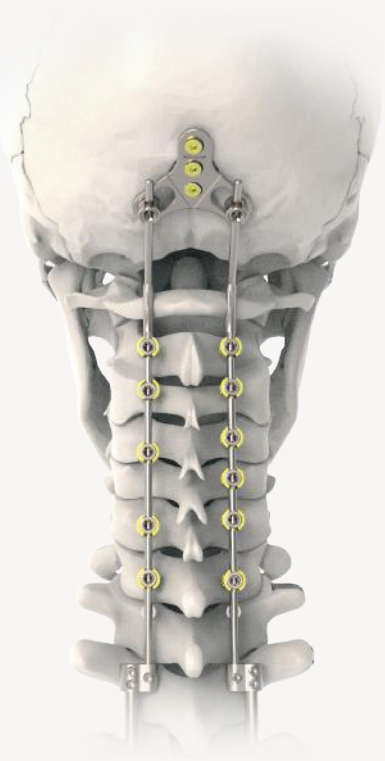

Oxis Polyaxial Screw (2 mm increments)

Product Code Diameter(mm) XX/L(mm)

NPCSS35XX	3.5	8-32
NPCSS40XX	4.0	8-32



Oxis Occipital Plate Screw (2 mm increments)

Product Code Diameter(mm) XX/L(mm)

NPCTOS35XX	3.5	6-20
NPCTOS40XX	4.0	6-20



Oxis Rod

Product Code D(mm) L(mm) Piece

NPCTR12	3.5	120	<input type="checkbox"/>
NPCTR14	3.5	140	<input type="checkbox"/>
NPCTR18	3.5	180	<input type="checkbox"/>
NPCTR24	3.5	240	<input type="checkbox"/>



Oxis Transverse Link

Product Code L(mm) Piece

NPCTL40	40	<input type="checkbox"/>
NPCTL50	50	<input type="checkbox"/>
NPCTL60	60	<input type="checkbox"/>
NPCTL70	70	<input type="checkbox"/>



Oxis Transverse Link Hook

Product Code Piece

NPCTLH	<input type="checkbox"/>
--------	--------------------------



D: Diameter(mm), L: Length(mm)

Features;

- Provide high strength with low thickness
- Provide effective and simple use
- Flexible blocking system securely lock screw

Oxis Domino Rod Connector

Product Code	Diameter(mm)		Piece
--------------	--------------	--	-------

NPCRC3560	3.5	6.0	<input type="checkbox"/>
-----------	-----	-----	--------------------------



Oxis Lateral Connectors

Product Code	Length(mm)	Piece
--------------	------------	-------

NPCLC10	10	<input type="checkbox"/>
NPCLC12	12	<input type="checkbox"/>



Oxis Laminar Hook

Product Code	Width(mm)	Length(mm)	Piece
--------------	-----------	------------	-------

NPCLH0405	4	5	<input type="checkbox"/>
NPCLH0406	4	6	<input type="checkbox"/>
NPCLH0407	4	7	<input type="checkbox"/>



Oxis Hybrid Rod

Product Code	Diameter(mm)		Length(mm)	Piece
--------------	--------------	--	------------	-------

NSHYR500	3.5	6.0	500	<input type="checkbox"/>
----------	-----	-----	-----	--------------------------



Oxis Occipital Rod/45° Angled

Product Code	Length(mm)	Piece
--------------	------------	-------

NPCORA	150	<input type="checkbox"/>
--------	-----	--------------------------



Oxis Occipital Plate

Product Code	Length(mm)	Piece
--------------	------------	-------

NPCHFS	45	<input type="checkbox"/>
NPCHFM	50	<input type="checkbox"/>
NPCHFL	55	<input type="checkbox"/>



Oxis Multiaxial Connector

Optional Implant	Length(mm)	Piece
------------------	------------	-------

	30-35	<input type="checkbox"/>
	35-43	<input type="checkbox"/>
	44-61	<input type="checkbox"/>

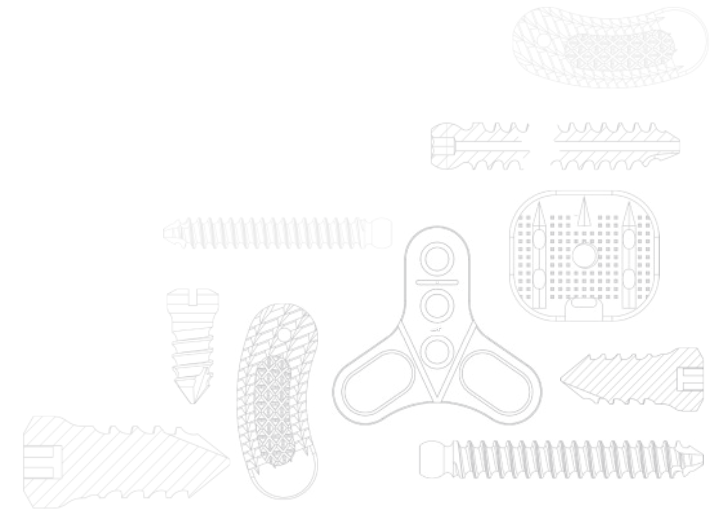

This implant system used with
Oxis-PLUS Instrument Set
 (Set Code: N-SS-005)

OXIS PLUS
 Posterior Cervical Occipitocervical
 Fixation System

D-FLEX Titanium Cervical Silicone Disc Prosthesis



This implant system used with Cervical Disc Prosthesis Instrument Set (Set Code: N-SS-021)

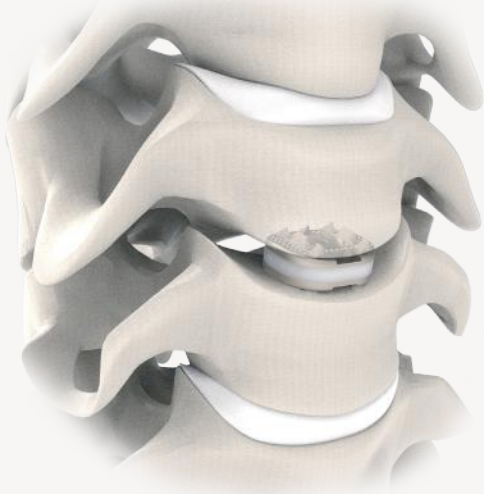

D-Flex Titanium Cervical Silicone Disc Prosthesis
Product Code H(mm) L(mm) W(mm) Piece

NCDSI12-05	5	12	14	
NCDSI14-05	5	14	14	
NCDSI16-05	5	14	16	
NCDSI12-06	6	12	14	
NCDSI14-06	6	14	14	
NCDSI16-06	6	14	16	
NCDSI12-07	7	12	14	
NCDSI14-07	7	14	14	
NCDSI16-07	7	14	16	
NCDSI12-08	8	12	14	
NCDSI14-08	8	14	14	
NCDSI16-08	8	14	16	

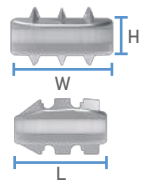

H: Height(mm), L: Length(mm), W: Width(mm)

Features;

- Comprise titanium endplates with core manufacture from flexible silicone
- Allow lateral bending, axial rotations, flexion and extension, shock absorption
- This product is one part so it is a great advantage for ease of use.
- Anatomical structure and high biomechanical performance

D-MOTION Peek Cervical Disc Prosthesis



This implant system used with Cervical Disc Prosthesis Instrument Set (Set Code: N-SS-021)

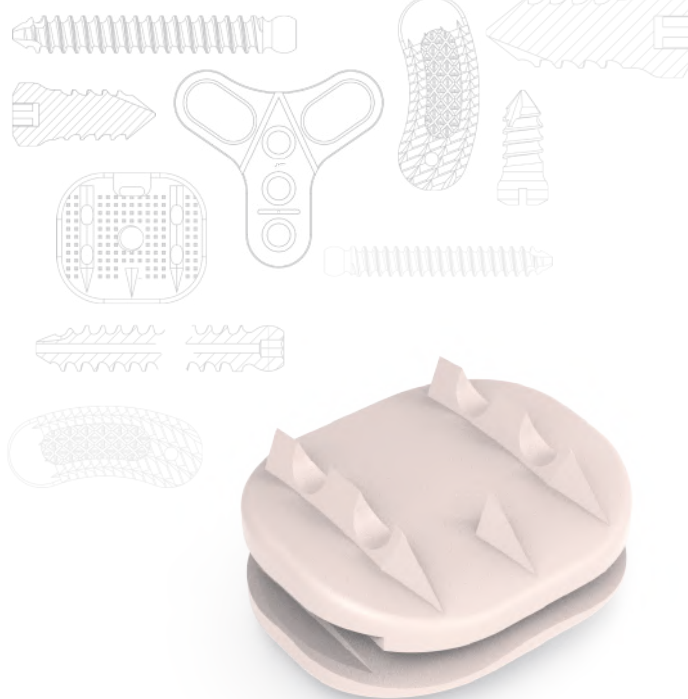
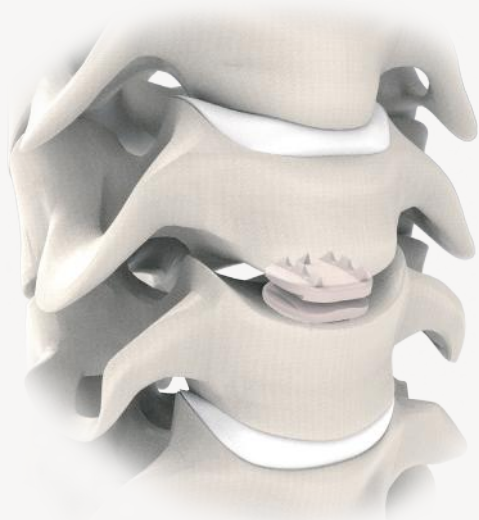

D-Motion Peek Cervical Disc Prosthesis

Product Code	H(mm)	L(mm)	W(mm)	Piece
NCDP1205	5	12	14	<input type="checkbox"/>
NCDP1405	5	14	14	<input type="checkbox"/>
NCDP1605	5	14	16	<input type="checkbox"/>
NCDP1206	6	12	14	<input type="checkbox"/>
NCDP1406	6	14	14	<input type="checkbox"/>
NCDP1606	6	14	16	<input type="checkbox"/>
NCDP1207	7	12	14	<input type="checkbox"/>
NCDP1407	7	14	14	<input type="checkbox"/>
NCDP1607	7	14	16	<input type="checkbox"/>
NCDP1208	8	12	14	<input type="checkbox"/>
NCDP1408	8	14	14	<input type="checkbox"/>
NCDP1608	8	14	16	<input type="checkbox"/>

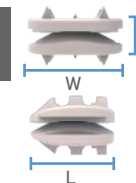

H: Height(mm), L: Length(mm), W: Width(mm)

Features;

- D-Motion is made from a radiolucent polymer (PEEK) for imaging compatibility
- Anatomical structure
- Permits a physiological range of motion in flexion, extension, rotation and lateral bending

D-PRO Titanium Cervical Disc Prosthesis



This implant system used with Cervical Disc Prosthesis Instrument Set (Set Code: N-SS-021)

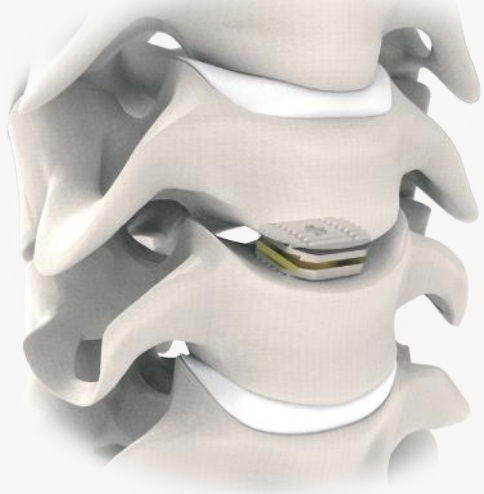

D-Pro Titanium Cervical Disc Prosthesis Product Code H(mm) L(mm) W(mm) Piece

NCDOP12-04	4	12	14	
NCDOP14-04	4	14	14	
NCDOP16-04	4	14	16	
NCDOP12-05	5	12	14	
NCDOP14-05	5	14	14	
NCDOP16-05	5	14	16	
NCDOP12-06	6	12	14	
NCDOP14-06	6	14	14	
NCDOP16-06	6	14	16	
NCDOP12-07	7	12	14	
NCDOP14-07	7	14	14	
NCDOP16-07	7	14	16	
NCDOP12-08	8	12	14	
NCDOP14-08	8	14	14	
NCDOP16-08	8	14	16	

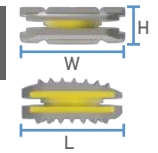

H: Height(mm), L: Length(mm), W: Width(mm)

Features;

- The physical structure of the device consists Titanium Alloy inferior and superior pieces
- Provide saving of time and facility with application method
- TIN coating avoids wear

SILVER

Posterior Thoracolumbar Fixation System



This implant system used with Plexus & Silver Posterior Spinal Instrument Set

(Set Code: N-SS-001)

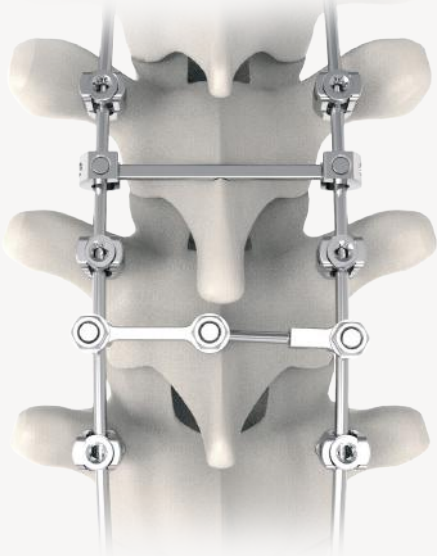

Silver Ion Coated Rapidfix Dual Lead Polyaxial Screw (5 mm increments)

Product Code	Diameter(mm)	XX/L(mm)
AB-NSPA045XX	4.5	20-45
AB-NSPA050XX	5.0	25-50
AB-NSPA055XX	5.5	20-55
AB-NSPA060XX	6.0	30-55
AB-NSPA065XX	6.5	25-60
AB-NSPA070XX	7.0	30-55
AB-NSPA075XX	7.5	25-100
AB-NSPA080XX	8.0	25-100



Silver Ion Coated Rapidfix Dual Lead Polyaxial Reduction Screw (5 mm increments)

Product Code	Diameter(mm)	XX/L(mm)
AB-NSPRS045XX	4.5	25-45
AB-NSPRS050XX	5.0	25-50
AB-NSPRS055XX	5.5	20-55
AB-NSPRS060XX	6.0	30-55
AB-NSPRS065XX	6.5	25-60
AB-NSPRS070XX	7.0	30-55
AB-NSPRS075XX	7.5	25-100
AB-NSPRS080XX	8.0	25-100



L: Length(mm)

Features;

- The feature of coating with nanoparticulate silver ions
- Reducing the infection rate and risk
- Decrease hospitalization period
- Antibacterial characteristic

Silver Ion Coated Rapidfix Dual Lead Monoaxial Screw (5 mm increments)
Product Code D(mm) XX/L(mm)

AB-NSMA040XX	4.0	20-45
AB-NSMA045XX	4.5	20-45
AB-NSMA050XX	5.0	25-50
AB-NSMA055XX	5.5	20-55
AB-NSMA060XX	6.0	30-55
AB-NSMA065XX	6.5	25-60
AB-NSMA070XX	7.0	30-55
AB-NSMA075XX	7.5	25-100
AB-NSMA080XX	8.0	25-100



Silver Ion Coated Rapidfix Dual Lead Reduction Monoaxial Screw (5 mm increments)
Product Code D(mm) XX/L(mm)

AB-NSMRS045XX	4.5	20-45
AB-NSMRS050XX	5.0	25-50
AB-NSMRS055XX	5.5	20-55
AB-NSMRS060XX	6.0	30-55
AB-NSMRS065XX	6.5	25-60
AB-NSMRS070XX	7.0	30-55
AB-NSMRS075XX	7.5	25-100
AB-NSMRS080XX	8.0	25-100



Silver Ion Coated Rapidfix Dual Lead Cannulated Fenestrated Polyaxial Screw (5 mm increments)
Product Code D(mm) XX/L(mm)

AB-NSPA055XX	5.5	30-55
AB-NSPA060XX	6.0	30-55
AB-NSPA065XX	6.5	30-55
AB-NSPA070XX	7.0	30-55
AB-NSPA075XX	7.5	30-55
AB-NSPA080XX	8.0	30-55



Silver Ion Coated Rod
Product Code D(mm) L(mm) Piece

AB-NSR1604	6.0	40
AB-NSR1605	6.0	50
AB-NSR1606	6.0	60
AB-NSR1607	6.0	70
AB-NSR1608	6.0	80
AB-NSR1609	6.0	90
AB-NSR1610	6.0	100
AB-NSR1611	6.0	110
AB-NSR1612	6.0	120
AB-NSR1613	6.0	130
AB-NSR1614	6.0	140
AB-NSR1615	6.0	150
AB-NSR1616	6.0	160
AB-NSR1617	6.0	170
AB-NSR1618	6.0	180
AB-NSR1619	6.0	190
AB-NSR1620	6.0	200
AB-NSR1621	6.0	210
AB-NSR1622	6.0	220
AB-NSR1623	6.0	230
AB-NSR1624	6.0	240
AB-NSR1625	6.0	250
AB-NSR1626	6.0	260
AB-NSR1627	6.0	270
AB-NSR1628	6.0	280
AB-NSR1629	6.0	290
AB-NSR1630	6.0	300
AB-NSR1640	6.0	400
AB-NSR1648	6.0	480
AB-NSR1650	6.0	500
AB-NSR1660	6.0	600



Silver Dynamic Rod
Product Code D(mm) L(mm) Piece

AB-NDNR6050	6.0	50
AB-NDNR6060	6.0	60
AB-NDNR6070	6.0	70
AB-NDNR6080	6.0	80
AB-NDNR6090	6.0	90
AB-NDNR6010	6.0	100
AB-NDNR60200	6.0	200



Silver Ion Coated Lateral Extension Connector
Product Code L(mm) Piece

AB-NSLCNT15	15
AB-NSLCNT20	20
AB-NSLCNT25	25
AB-NSLCNT30	30
AB-NSLCNT40	40



Silver Ion Coated Transverse Link Multiaxial
Product Code L(mm) Piece

AB-NSATL2040	20-40
AB-NSATL4060	40-60
AB-NSATL6080	60-80
AB-NSATL80100	80-100



Silver Ion Coated Pedicular Hook
Product Code W(mm)L(mm) Piece

AB-NPPH0505	5	5
AB-NPPH0507	5	7
AB-NPPH0805	8	5
AB-NPPH0807	8	7
AB-NPPH0809	8	9

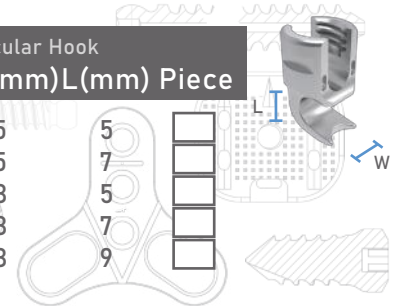

D: Diameter(mm), L: Length(mm)
 Cannulated and Fenestrated screws are used with a 3.5 hex screwdriver.



This implant system used with Plexus & Silver Posterior Spinal Instrument Set
 (Set Code: N-SS-001)

SILVER
 Posterior Thoracolumbar
 Fixation System

Silver Ion Coated Laminar Hook

Product Code W(mm)L(mm) Piece

AB-NPLH0505	5	5	<input type="checkbox"/>
AB-NPLH0507	5	7	<input type="checkbox"/>
AB-NPLH0509	5	9	<input type="checkbox"/>
AB-NPLH0706	7	6	<input type="checkbox"/>
AB-NPLH0707	7	7	<input type="checkbox"/>
AB-NPLH0709	7	9	<input type="checkbox"/>
AB-NPLH0711	7	11	<input type="checkbox"/>



Right

Silver Ion Coated Laminar Angle 20° Left & Right Hook

Product Code W(mm)L(mm) Piece

AB-NPLHLA709	7	9	<input type="checkbox"/>
AB-NPLHLA711	7	11	<input type="checkbox"/>
AB-NPLHRA709	7	9	<input type="checkbox"/>
AB-NPLHRA711	7	11	<input type="checkbox"/>



Silver Ion Coated Laminar Flexible Hook

Product Code W(mm)L(mm) Piece

AB-NLHF0505	5	5	<input type="checkbox"/>
AB-NLHF0507	5	7	<input type="checkbox"/>



Silver Ion Coated Pedicle Flexible Hook

Product Code W(mm)L(mm) Piece

AB-NPHF0505	5	5	<input type="checkbox"/>
AB-NPHF0507	5	7	<input type="checkbox"/>



Silver Ion Coated Transverse Link

Product Code L(mm) Piece

AB-NSTL140	40	<input type="checkbox"/>
AB-NSTL150	50	<input type="checkbox"/>
AB-NSTL160	60	<input type="checkbox"/>
AB-NSTL170	70	<input type="checkbox"/>
AB-NSTL180	80	<input type="checkbox"/>



Silver Ion Coated Transverse Link Hook

Product Code Piece

AB-NSTLH	<input type="checkbox"/>
----------	--------------------------

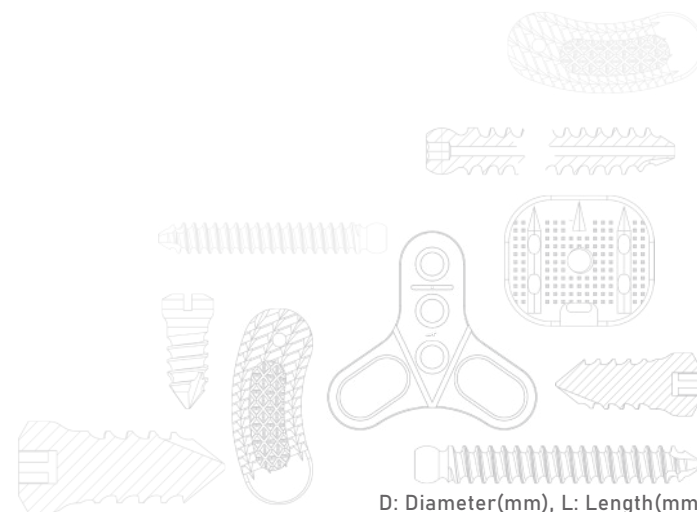

This implant system used with **Plexus & Silver Posterior Spinal Instrument Set**
(Set Code: N-SS-001)

SILVER
Posterior Thoracolumbar
Fixation System

LEVISSI

Posterior Thoracolumbar MIS Screw System



This implant system used with Levissi MIS Screw System Instrument Set

(Set Code: N-SS-004)



Levissi MIS Ø6.0 Curved Rod (10 mm increments)

Product Code Diameter(mm) XXX/L(mm)

NLMISR6XXXC 6.0 040-120



Levissi MIS Ø6.0 Straight Rod (10 mm increments)

Product Code Diameter(mm) XXX/L(mm)

NLMISR6XXXS 6.0 040-200



Levissi MIS Dual Lead Cannulated Polyaxial Screw (5 mm increments)

Product Code Diameter(mm) XX/L(mm)

NLMIS55XX 5.5 30-50
 NLMIS65XX 6.5 30-55
 NLMIS75XX 7.5 30-50



Levissi MIS Dual Lead Cannulated Fenestrated Polyaxial Screw (5 mm increments)

Product Code Diameter(mm) XX/L(mm)

NSPAKH055XX 5.5 30-50
 NSPAKH065XX 6.5 30-55
 NSPAKH075XX 7.5 30-50



Levissi MIS Quad Lead Cannulated Polyaxial Screw (5 mm increments)

Product Code Diameter(mm) XX/L(mm)

NQCPS55XX 5.5 30-50
 NQCPS65XX 6.5 30-55
 NQCPS75XX 7.5 30-50



Levissi MIS Quad Lead Cannulated Fenestrated Polyaxial Screw (5 mm increments)

Product Code Diameter(mm) XX/L(mm)

NQSPA055XX 5.5 30-50
 NQSPA065XX 6.5 30-55
 NQSPA075XX 7.5 30-50



L: Length(mm)

Features;

- The Levissi MIS Spinal System is a thoracolumbar system designed to facilitate percutaneous screw and rod placement.
- The cannulated pedicle screws and extended reduction tabs allow for easy rod placement and minimal tissue disruption

Rapidfix

Dual Lead Thoracolumbar Screws



These screws are used with
Tower Fix Scoliosis
Deformity Instrument Set
and Plexus & Silver
Posterior Spinal Instrument
Set

(Set Code: N-SS-002, Set Code: N-SS-001)

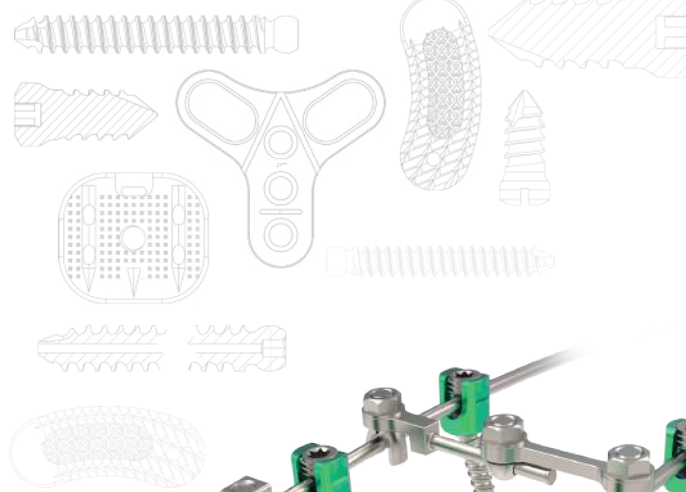
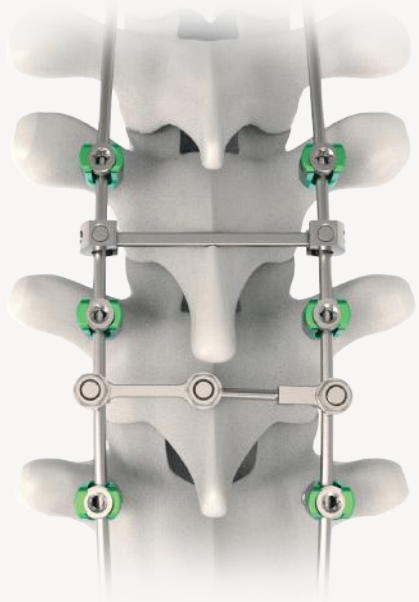

Rapidfix Dual Lead Polyaxial Screw (5 mm increments)

Product Code	Diameter(mm)	XX/L(mm)
NSPAK45XX	4.5	20-45
NSPAK50XX	5.0	25-50
NSPAK55XX	5.5	20-55
NSPAK60XX	6.0	30-55
NSPAK65XX	6.5	25-60
NSPAK70XX	7.0	30-55
NSPAK75XX	7.5	25-100
NSPAK80XX	8.0	25-100



Rapidfix Dual Lead Reduction Polyaxial Screw (5 mm increments)

Product Code	Diameter(mm)	XX/L(mm)
NSPAKR45XX	4.5	25-45
NSPAKR50XX	5.0	25-50
NSPAKR55XX	5.5	20-55
NSPAKR60XX	6.0	30-55
NSPAKR65XX	6.5	25-60
NSPAKR70XX	7.0	30-55
NSPAKR75XX	7.5	25-100
NSPAKR80XX	8.0	25-100



L: Length(mm)

Features;

- Rapidfix Dual Lead screw design displays a superior pullout compared to competitor design fast and controlled Insertion
- Combination of two threads having the same form of a double threaded.
- Excellent tactile feedback on bone purchase of screw thanks to combination of double lead

Rapidfix Dual Lead Cannulated Fenestrated Polyaxial Screw (5 mm increments)
Product Code D(mm) XX/L(mm)

NSPA KH55XX	5.5	30-55
NSPA KH60XX	6.0	30-55
NSPA KH65XX	6.5	30-55
NSPA KH70XX	7.0	30-55
NSPA KH75XX	7.5	30-55
NSPA KH80XX	8.0	30-55



Rapidfix Dual Lead Monoaxial Screw (5 mm increments)
Product Code D(mm) XX/L(mm)

N SMAK40XX	4.0	20-45
N SMAK45XX	4.5	20-45
N SMAK50XX	5.0	25-50
N SMAK55XX	5.5	20-55
N SMAK60XX	6.0	30-55
N SMAK65XX	6.5	25-60
N SMAK70XX	7.0	30-55
N SMAK75XX	7.5	25-100
N SMAK80XX	8.0	25-100



Rapidfix Dual Lead Reduction Monoaxial Screw (5 mm increments)
Product Code D(mm) XX/L(mm)

N SMAKR45XX	4.5	20-45
N SMAKR50XX	5.0	25-50
N SMAKR55XX	5.5	20-55
N SMAKR60XX	6.0	30-55
N SMAKR65XX	6.5	25-60
N SMAKR70XX	7.0	30-55
N SMAKR75XX	7.5	25-100
N SMAKR80XX	8.0	25-100



Plexus Rod
Product Code D(mm) L(mm) Piece

NSR15504	5.5	40	<input type="checkbox"/>
NSR15505	5.5	50	<input type="checkbox"/>
NSR15506	5.5	60	<input type="checkbox"/>
NSR15507	5.5	70	<input type="checkbox"/>
NSR15508	5.5	80	<input type="checkbox"/>
NSR15509	5.5	90	<input type="checkbox"/>
NSR15510	5.5	100	<input type="checkbox"/>
NSR15511	5.5	110	<input type="checkbox"/>
NSR15512	5.5	120	<input type="checkbox"/>
NSR15513	5.5	130	<input type="checkbox"/>
NSR15514	5.5	140	<input type="checkbox"/>
NSR15540	5.5	400	<input type="checkbox"/>
NSR15550	5.5	500	<input type="checkbox"/>
NSR15560	5.5	600	<input type="checkbox"/>
NSR1604	6.0	40	<input type="checkbox"/>
NSR1605	6.0	50	<input type="checkbox"/>
NSR1606	6.0	60	<input type="checkbox"/>
NSR1607	6.0	70	<input type="checkbox"/>
NSR1608	6.0	80	<input type="checkbox"/>
NSR1609	6.0	90	<input type="checkbox"/>
NSR1610	6.0	100	<input type="checkbox"/>
NSR1611	6.0	110	<input type="checkbox"/>
NSR1612	6.0	120	<input type="checkbox"/>
NSR1613	6.0	130	<input type="checkbox"/>
NSR1614	6.0	140	<input type="checkbox"/>
NSR1615	6.0	150	<input type="checkbox"/>
NSR1616	6.0	160	<input type="checkbox"/>
NSR1617	6.0	170	<input type="checkbox"/>
NSR1618	6.0	180	<input type="checkbox"/>
NSR1619	6.0	190	<input type="checkbox"/>
NSR1620	6.0	200	<input type="checkbox"/>
NSR1621	6.0	210	<input type="checkbox"/>
NSR1622	6.0	220	<input type="checkbox"/>



Rod
Product Code D(mm) L(mm) Piece

NSR1623	6.0	230	<input type="checkbox"/>
NSR1624	6.0	240	<input type="checkbox"/>
NSR1625	6.0	250	<input type="checkbox"/>
NSR1626	6.0	260	<input type="checkbox"/>
NSR1627	6.0	270	<input type="checkbox"/>
NSR1628	6.0	280	<input type="checkbox"/>
NSR1629	6.0	290	<input type="checkbox"/>
NSR1630	6.0	300	<input type="checkbox"/>
NSR1631	6.0	310	<input type="checkbox"/>
NSR1632	6.0	320	<input type="checkbox"/>
NSR1640	6.0	400	<input type="checkbox"/>
NSR1648	6.0	480	<input type="checkbox"/>
NSR1650	6.0	500	<input type="checkbox"/>
NSR1660	6.0	600	<input type="checkbox"/>



Cr-Co Rod
Product Code D(mm) L(mm) Piece

N SCRR15504	5.5	40	<input type="checkbox"/>
N SCRR15505	5.5	50	<input type="checkbox"/>
N SCRR15506	5.5	60	<input type="checkbox"/>
N SCRR15507	5.5	70	<input type="checkbox"/>
N SCRR15508	5.5	80	<input type="checkbox"/>
N SCRR15509	5.5	90	<input type="checkbox"/>
N SCRR15510	5.5	100	<input type="checkbox"/>
N SCRR15511	5.5	110	<input type="checkbox"/>
N SCRR15512	5.5	120	<input type="checkbox"/>
N SCRR15513	5.5	130	<input type="checkbox"/>
N SCRR15514	5.5	140	<input type="checkbox"/>
N SCRR15540	5.5	400	<input type="checkbox"/>
N SCRR15550	5.5	500	<input type="checkbox"/>
N SCRR15560	5.5	600	<input type="checkbox"/>
N SCRR1604	6.0	40	<input type="checkbox"/>
N SCRR1605	6.0	50	<input type="checkbox"/>

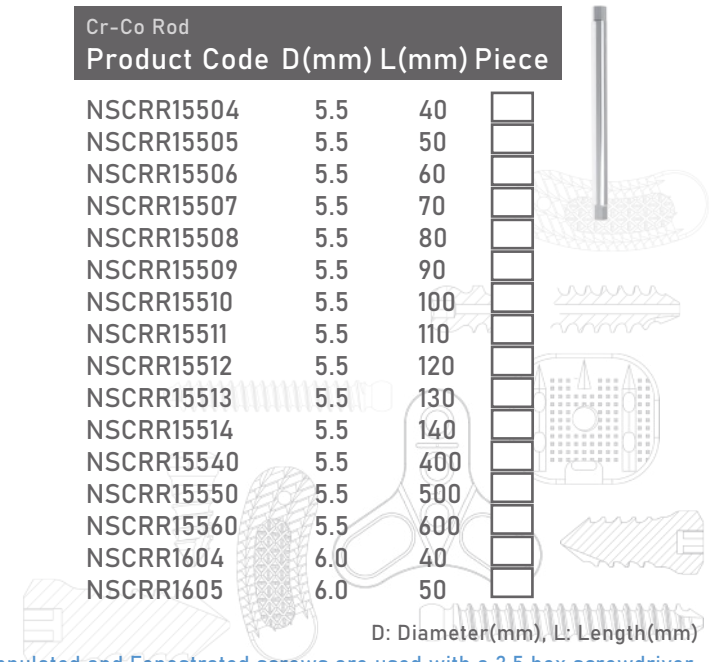

D: Diameter(mm), L: Length(mm)

Cannulated and Fenestrated screws are used with a 3.5 hex screwdriver.



This implant system used with **Tower Fix Scoliosis Deformity Instrument Set** and **Plexus & Silver Posterior Spinal Instrument Set**
 (Set Code: N-SS-002, Set Code: N-SS-001)

Rapidfix
 Dual Lead Thracolumbar
 Screws

Cr-Co Rod

Product Code D(mm) L(mm) Piece

NSCRR1606	6.0	60	<input type="checkbox"/>
NSCRR1607	6.0	70	<input type="checkbox"/>
NSCRR1608	6.0	80	<input type="checkbox"/>
NSCRR1609	6.0	90	<input type="checkbox"/>
NSCRR1610	6.0	100	<input type="checkbox"/>
NSCRR1611	6.0	110	<input type="checkbox"/>
NSCRR1612	6.0	120	<input type="checkbox"/>
NSCRR1613	6.0	130	<input type="checkbox"/>
NSCRR1614	6.0	140	<input type="checkbox"/>
NSCRR1615	6.0	150	<input type="checkbox"/>
NSCRR1616	6.0	160	<input type="checkbox"/>
NSCRR1617	6.0	170	<input type="checkbox"/>
NSCRR1618	6.0	180	<input type="checkbox"/>
NSCRR1619	6.0	190	<input type="checkbox"/>
NSCRR1620	6.0	200	<input type="checkbox"/>
NSCRR1621	6.0	210	<input type="checkbox"/>
NSCRR1622	6.0	220	<input type="checkbox"/>
NSCRR1623	6.0	230	<input type="checkbox"/>
NSCRR1624	6.0	240	<input type="checkbox"/>
NSCRR1625	6.0	250	<input type="checkbox"/>
NSCRR1626	6.0	260	<input type="checkbox"/>
NSCRR1627	6.0	270	<input type="checkbox"/>
NSCRR1628	6.0	280	<input type="checkbox"/>
NSCRR1629	6.0	290	<input type="checkbox"/>
NSCRR1630	6.0	300	<input type="checkbox"/>
NSCRR1631	6.0	310	<input type="checkbox"/>
NSCRR1632	6.0	320	<input type="checkbox"/>
NSCRR1640	6.0	400	<input type="checkbox"/>
NSCRR1648	6.0	480	<input type="checkbox"/>
NSCRR1650	6.0	500	<input type="checkbox"/>
NSCRR1660	6.0	600	<input type="checkbox"/>



Laminar Hook

Product Code W(mm)L(mm) Piece

NPLH0505	5	5	<input type="checkbox"/>
NPLH0507	5	7	<input type="checkbox"/>
NPLH0509	5	9	<input type="checkbox"/>
NPLH0706	7	6	<input type="checkbox"/>
NPLH0707	7	7	<input type="checkbox"/>
NPLH0709	7	9	<input type="checkbox"/>
NPLH0711	7	11	<input type="checkbox"/>



Pedicular Hook

Product Code W(mm)L(mm) Piece

NPPH0505	5	5	<input type="checkbox"/>
NPPH0507	5	7	<input type="checkbox"/>
NPPH0805	8	5	<input type="checkbox"/>
NPPH0807	8	7	<input type="checkbox"/>
NPPH0809	8	9	<input type="checkbox"/>



Laminar Flexible Hook

Product Code W(mm)L(mm) Piece

NLHF0505	5	5	<input type="checkbox"/>
NLHF0507	5	7	<input type="checkbox"/>



Pedicle Flexible Hook

Product Code W(mm)L(mm) Piece

NPHF0505	5	5	<input type="checkbox"/>
NPHF0507	5	7	<input type="checkbox"/>



Laminar Angle 20° Left & Right Hook

Product Code W(mm)L(mm) Piece

NPLHLA709	7	9	<input type="checkbox"/>
NPLHLA711	7	11	<input type="checkbox"/>
NPLHRA709	7	9	<input type="checkbox"/>
NPLHRA711	7	11	<input type="checkbox"/>



Domino Rod Connector

Product Code D(mm) Piece

NSECNT01	5.5	<input type="checkbox"/>
NSECNT02	6.0	<input type="checkbox"/>



Dynamic Rod

Product Code D(mm) L(mm) Piece

NDNR6050	6.0	50	<input type="checkbox"/>
NDNR6060	6.0	60	<input type="checkbox"/>
NDNR6070	6.0	70	<input type="checkbox"/>
NDNR6080	6.0	80	<input type="checkbox"/>
NDNR6090	6.0	90	<input type="checkbox"/>
NDNR6010	6.0	100	<input type="checkbox"/>



Lateral Extension Connector

Product Code L(mm) Piece

NSLCNT15	15	<input type="checkbox"/>
NSLCNT20	20	<input type="checkbox"/>
NSLCNT25	25	<input type="checkbox"/>
NSLCNT30	30	<input type="checkbox"/>
NSLCNT40	40	<input type="checkbox"/>



Transverse Link Multiaxial

Product Code L(mm) Piece

NSATL2040	20-40	<input type="checkbox"/>
NSATL4060	40-60	<input type="checkbox"/>
NSATL6080	60-80	<input type="checkbox"/>
NSATL80100	80-100	<input type="checkbox"/>

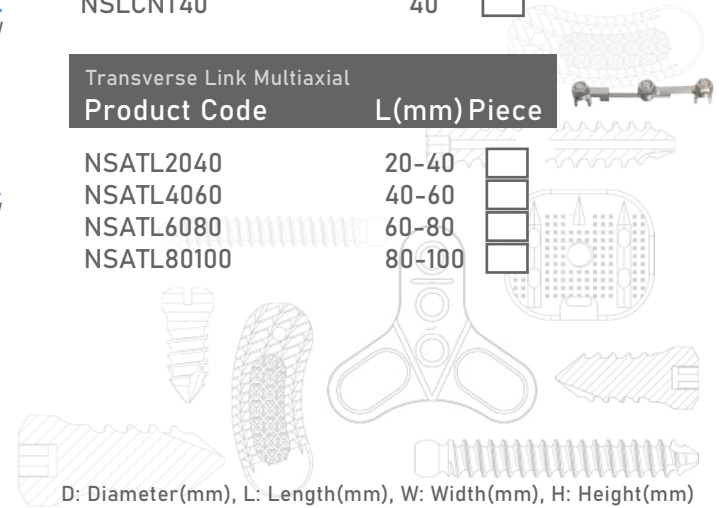

D: Diameter(mm), L: Length(mm), W: Width(mm), H: Height(mm)



This implant system used with **Tower Fix Scoliosis Deformity Instrument Set** and **Plexus & Silver Posterior Spinal Instrument Set**
(Set Code: N-SS-002, Set Code: N-SS-001)

Rapidfix
Dual Lead Thracolumbar
Screws

Transverse Link

Product Code L(mm) Piece

NSTL140	40	<input type="checkbox"/>
NSTL150	50	<input type="checkbox"/>
NSTL160	60	<input type="checkbox"/>
NSTL170	70	<input type="checkbox"/>
NSTL180	80	<input type="checkbox"/>



Transverse Link Hook

Product Code Piece

NSTLH	<input type="checkbox"/>
-------	--------------------------



Sacral Connector

Product Code L(mm) Piece

NSSC15	15	<input type="checkbox"/>
NSSC20	20	<input type="checkbox"/>



Plexus Sacroiliac

Polyaxial Screw (5 mm increments)

Product Code D(mm) XX/L(mm)

NSICS80XX	8.0	70-120
-----------	-----	--------

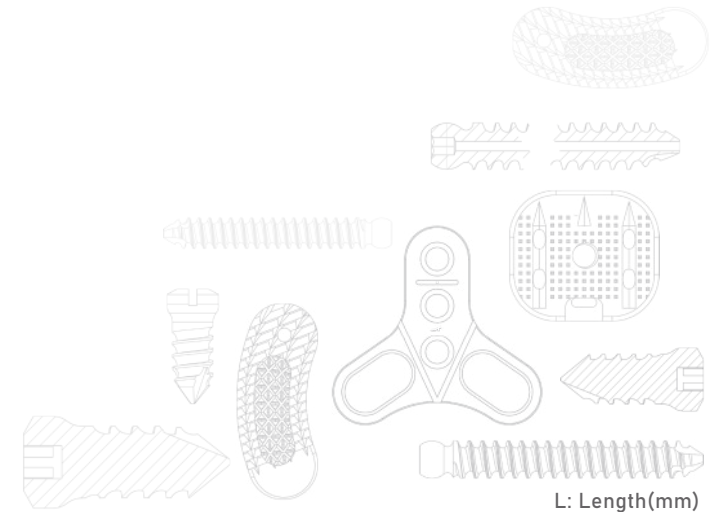

L: Length(mm)



This implant system used with **Tower Fix Scoliosis Deformity Instrument Set** and **Plexus & Silver Posterior Spinal Instrument Set**
 (Set Code: N-SS-002, Set Code: N-SS-001)

Rapidfix
 Dual Lead Thracolumbar
 Screws

Quatro

Quad Lead Thoracolumbar Screws



These screws are used with
**Tower Fix Scoliosis
Deformity Instrument Set**
and **Plexus & Silver
Posterior Spinal Instrument
Set**

(Set Code: N-SS-002, Set Code: N-SS-001)

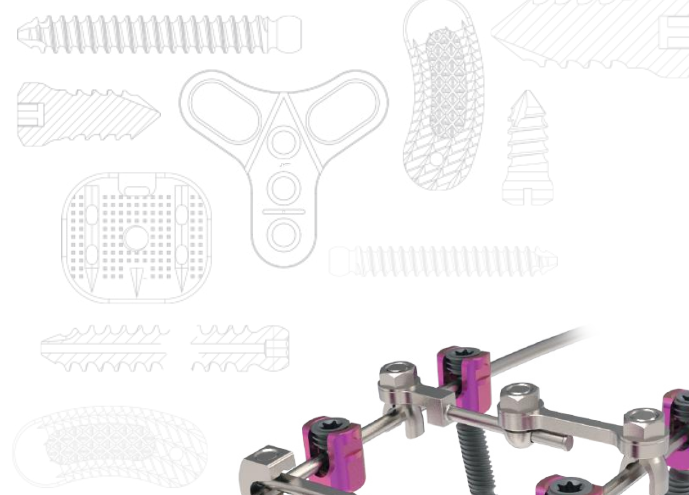
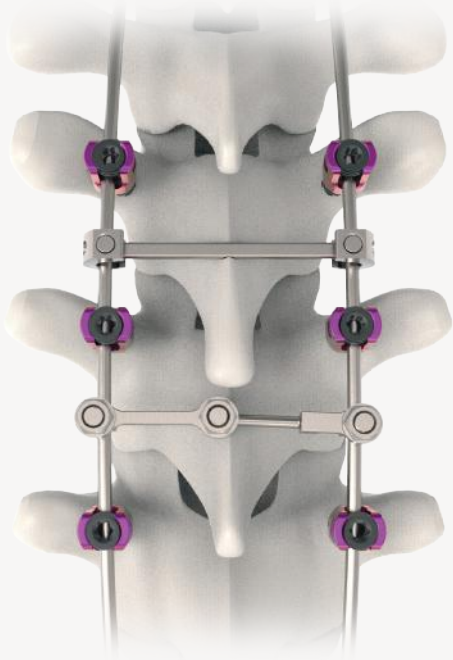

Quatro Quad Lead Polyaxial Screw (5 mm increments)

Product Code	Diameter(mm)	XX/L(mm)
NQSPA45XX	4.5	20-45
NQSPA50XX	5.0	25-50
NQSPA55XX	5.5	20-55
NQSPA60XX	6.0	30-55
NQSPA65XX	6.5	25-60
NQSPA70XX	7.0	30-55
NQSPA75XX	7.5	25-100



Quatro Quad Lead Cannulated Fenestrated Polyaxial Screw (5 mm increments)

Product Code	Diameter(mm)	XX/L(mm)
NQSPAH55XX	5.5	30-55
NQSPAH60XX	6.0	30-55
NQSPAH65XX	6.5	30-55
NQSPAH70XX	7.0	30-55
NQSPAH75XX	7.5	30-55



Quatro Quad Lead Polyaxial Reduction Screw (5 mm increments)

Product Code	Diameter(mm)	XX/L(mm)
NQSPAR40XX	4.0	20-45
NQSPAR45XX	4.5	20-55
NQSPAR50XX	5.0	25-55
NQSPAR55XX	5.5	20-55
NQSPAR60XX	6.0	30-55
NQSPAR65XX	6.5	30-60
NQSPAR70XX	7.0	30-55
NQSPAR75XX	7.5	25-100



L: Length(mm)

Cannulated and Fenestrated screws are used with a 3.5 hex screwdriver.

Features;

- Distal tip teeth to enable insertion without pedicle prep
- Constant thread lead
- Cortical thread form support enhanced pedicle fixation
- Best pullout performance

PEDIFIX

Posterior Thoracolumbar Fixation System



This implant system used with Pedifix Instrument Set

(Set Code: N-SS-020)

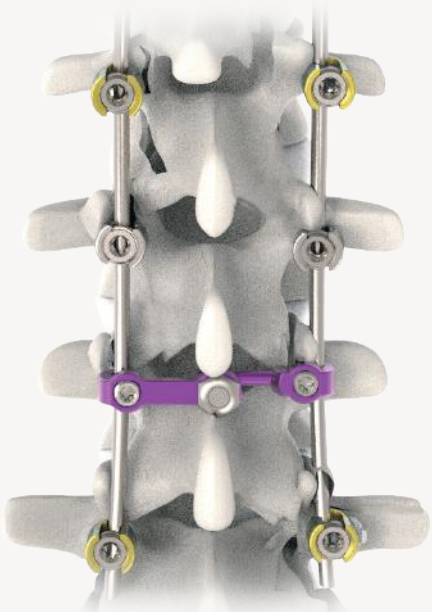

Pedifix Polyaxial Screw (5 mm increments)

Product Code	Diameter(mm)	XX/L(mm)
NPXPS40XX	4.0	20-40
NPXPS45XX	4.5	25-50
NPXPS50XX	5.0	25-50
NPXPS55XX	5.5	25-50
NPXPS60XX	6.0	30-50



Pedifix Polyaxial Reduction Screw (5 mm increments)

Product Code	Diameter(mm)	XX/L(mm)
NPXPRS45XX	4.5	20-50
NPXPRS55XX	5.5	25-50
NPXPRS60XX	6.0	30-50



Pedifix Monoaxial Screw (5 mm increments)

Product Code	Diameter(mm)	XX/L(mm)
NPXMS40XX	4.0	20-40
NPXMS45XX	4.5	25-45
NPXMS50XX	5.0	25-50
NPXMS55XX	5.5	25-50
NPXMS60XX	6.0	30-50



L: Length(mm)

Features;

- Low profile tulip head (12.3mm) allows you to more directly visualize the surgical site
- Thread pattern optimized for cortical bone at the proximal end and cancellous bone at the distal end
- Designed to treat a wide range of deformities including adolescent idiopathic scoliosis (AIS) congenital scoliosis, neuromuscular scoliosis

Pedifix Monoblock Cross Connectors

Product Code	L(mm)	Piece
NPXMC12	12	<input type="checkbox"/>
NPXMC13	13	<input type="checkbox"/>
NPXMC14	14	<input type="checkbox"/>
NPXMC15	15	<input type="checkbox"/>
NPXMC16	16	<input type="checkbox"/>
NPXMC17	17	<input type="checkbox"/>
NPXMC18	18	<input type="checkbox"/>
NPXMC19	19	<input type="checkbox"/>
NPXMC20	20	<input type="checkbox"/>
NPXMC21	21	<input type="checkbox"/>
NPXMC22	22	<input type="checkbox"/>
NPXMC23	23	<input type="checkbox"/>
NPXMC24	24	<input type="checkbox"/>



Pedifix Dual Staple Caudal

Product Code	Size	Piece
NPXDSC(L)	Large	<input type="checkbox"/>
NPXDSC(S)	Small	<input type="checkbox"/>



Pedifix Dual Staple Rostral

Product Code	Size	Piece
NPXDSR(L)		<input type="checkbox"/>
NPXDSR(S)		<input type="checkbox"/>



Pedifix Pedicle Hook

Product Code	Size	Piece
NPXPH(L)	Large	<input type="checkbox"/>
NPXPH(S)	Small	<input type="checkbox"/>



Pedifix Transverse Proses Hook

Product Code	Side	Piece
NPXTHL	Left	<input type="checkbox"/>
NPXTHR	Right	<input type="checkbox"/>



Pedifix Thoracic Hook Offset

Product Code	Side	Piece
NPXTHOL	Left	<input type="checkbox"/>
NPXTHOR	Right	<input type="checkbox"/>



Pedifix Supralaminar Thoracic Hook

Product Code	Side	Piece
NPXSH(L)	Left	<input type="checkbox"/>
NPXSH(R)	Right	<input type="checkbox"/>



Pedifix Rod

Product Code	L(mm)	Piece
NPXR030	30	<input type="checkbox"/>
NPXR040	40	<input type="checkbox"/>
NPXR050	50	<input type="checkbox"/>
NPXR060	60	<input type="checkbox"/>
NPXR070	70	<input type="checkbox"/>
NPXR080	80	<input type="checkbox"/>
NPXR090	90	<input type="checkbox"/>
NPXR100	100	<input type="checkbox"/>
NPXR200	200	<input type="checkbox"/>
NPXR480	480	<input type="checkbox"/>



Pedifix Laminar Hook

Product Code	Size	Piece
NPXLH(L)	Large	<input type="checkbox"/>
NPXLH(M)	Medium	<input type="checkbox"/>
NPXLH(S)	Small	<input type="checkbox"/>



Pedifix Laminar Hook Angled Blade

Product Code	Size	Piece
NPXLHA		<input type="checkbox"/>



Pedifix Thoracic Laminar Hook Ramped

Product Code	Piece
NPXLHR	<input type="checkbox"/>



Pedifix Extended Body Laminar Hook

Product Code	Piece
NPXLHE	<input type="checkbox"/>



Pedifix Rod to Rod Connector

Product Code	D(mm)	Piece
NPXPDC4535	4.5-3.5	<input type="checkbox"/>
NPXPDC4545	4.5-4.5	<input type="checkbox"/>
NPXPDC4560	4.5-6.0	<input type="checkbox"/>



Pedifix Rod to Rod Connector

Product Code	D(mm)	Size	Piece
NPXPDCS4545	4.5-4.5	Small	<input type="checkbox"/>
NPXPDCS4560	4.5-6.0	Small	<input type="checkbox"/>
NPXPDCS4545	4.5-4.5	Large	<input type="checkbox"/>
NPXPDCS4560	4.5-6.0	Large	<input type="checkbox"/>

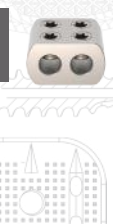

Pedifix Single Staple

Product Code	Piece
NPXSS	<input type="checkbox"/>

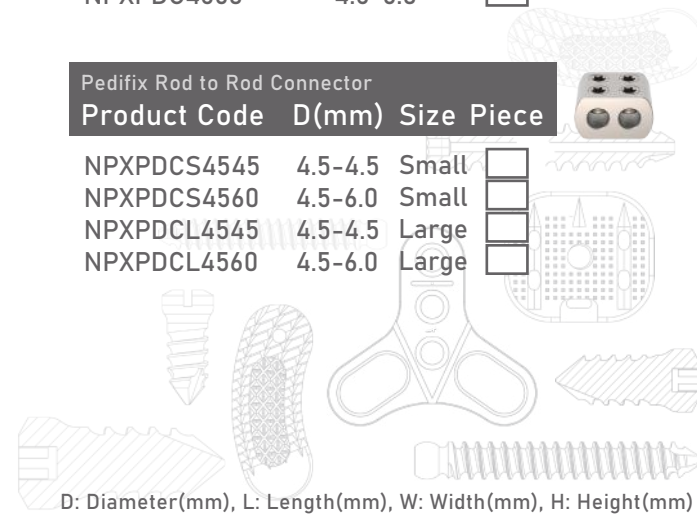

i This implant system used with
Pedifix Instrument Set
 (Set Code: N-SS-020)

PEDIFIX
 Posterior Thoracolumbar
 Fixation System

Pedifix Offset Connector

Product Code	L(mm)	Piece
NPXOC30	30	<input type="checkbox"/>
NPXOC70	70	<input type="checkbox"/>



Pedifix Extended Connector

Product Code	L(mm)	Side	Piece
NPXEC(S)	30	Small	<input type="checkbox"/>
NPXEC(L)	60	Large	<input type="checkbox"/>



Pedifix Parallel Connector

Product Code	Angle	Piece
NPXIC00		<input type="checkbox"/>



Pedifix Iliac Connector

Product Code	Angle	Piece
NPXIC15	15°	<input type="checkbox"/>
NPXIC25	25°	<input type="checkbox"/>
NPXIC35	35°	<input type="checkbox"/>
NPXIC45	45°	<input type="checkbox"/>



Pedifix Polyaxial Cross Connector

Product Code	L(mm)	Side	Piece
NPXPC2430	24-30	Small	<input type="checkbox"/>
NPXPC3036	30-36	Medium	<input type="checkbox"/>
NPXPC3645	36-45	Large	<input type="checkbox"/>
NPXPC4560	45-60	X-Large	<input type="checkbox"/>

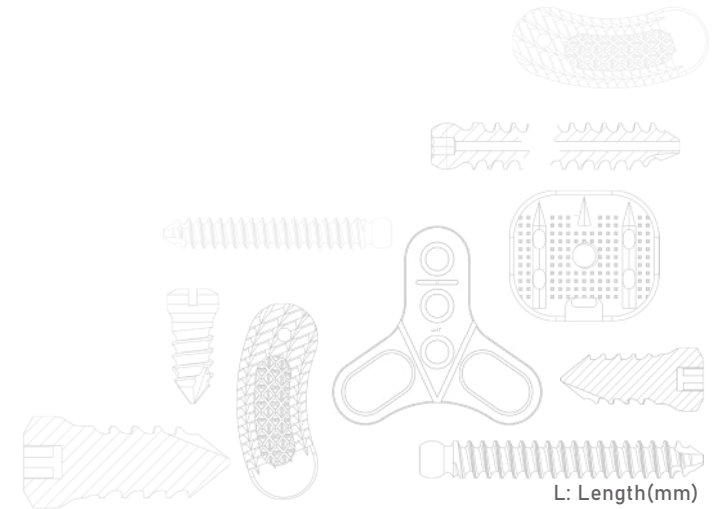

L: Length(mm)



This implant system used with
Pedifix Instrument Set
 (Set Code: N-SS-020)

PEDIFIX
 Posterior Thoracolumbar
 Fixation System

ZEK

Anterior Thoracolumbar Corpectomy Cage



This implant system used with Vertelift - T Instrument Set
(Set Code: N-SS-007)

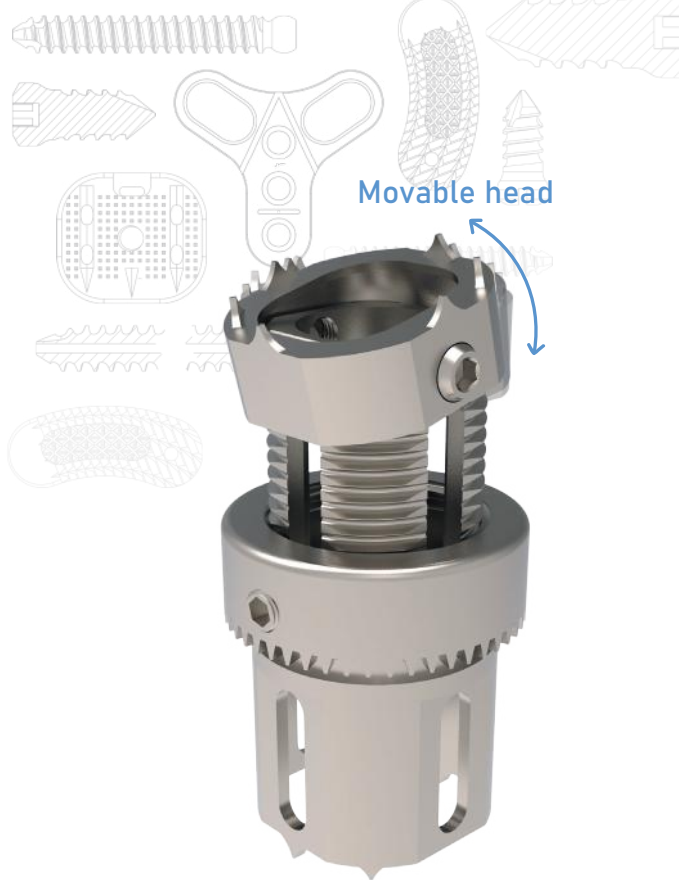

Zek Corpectomy Cage				
Product Code	D(mm)	CL(mm)	OL(mm)	Piece
NVTCZ203244	20	32	44	
NVTCZ204258	20	42	58	
NVTCZ205684	20	56	84	
NVTCZ242840	24	28	40	
NVTCZ243854	24	38	54	
NVTCZ245276	24	52	76	
NVTCZ2474114	24	74	114	
NVTCZ283244	28	32	44	
NVTCZ284258	28	42	58	
NVTCZ285684	28	56	84	



D: Diameter(mm), CL: Closed Length(mm), OL: Opened Length(mm)

Features;

- Full contact, full fusion through unique movable head technology
- Fit with the anatomy of patient
- Adjustable easily with threaded mechanism
- Adjustable easily with threaded surface

VERTELIFT-T

Anterior Thoracolumbar Corpectomy Cage



This implant system used with Vertelift - T Instrument Set
(Set Code: N-SS-007)

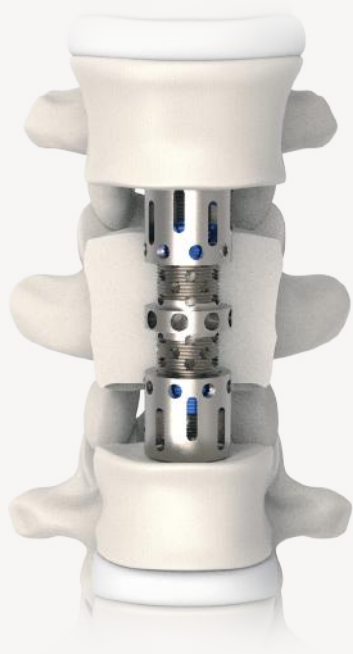

Vertelift-T Corpectomy Cage - Angled

Product Code	D(mm)	CL(mm)	OL(mm)	Angle	Piece
NVTCD202534	20	25	34	-	
NVTCD203244	20	32	44	-	
NVTCD204258	20	42	58	-	
NVTCD205684	20	56	84	-	
NVTCA202534	20	25	34	6°	
NVTCA203244	20	32	44	6°	
NVTCA204258	20	42	58	6°	
NVTCA205684	20	56	84	6°	
NVTCD242329	24	23	29	-	
NVTCD242840	24	28	40	-	
NVTCD243854	24	38	54	-	
NVTCD245276	24	52	76	-	
NVTCD2474114	24	74	114	-	
NVTCA242329	24	23	29	6°	
NVTCA242840	24	28	40	6°	
NVTCA243854	24	38	54	6°	
NVTCA245276	24	52	76	6°	
NVTCA2474114	24	74	114	6°	
NVTCD283244	28	32	44	-	
NVTCD284258	28	42	58	-	
NVTCD285684	28	56	84	-	
NVTCD2882130	28	82	130	-	
NVTCD28100140	28	100	140	-	
NVTCA283244	28	32	44	6°	
NVTCA284258	28	42	58	6°	
NVTCA285684	28	56	84	6°	
NVTCA2882130	28	82	130	6°	
NVTCA28100140	28	100	140	6°	



D: Diameter(mm), CL: Closed Length(mm), OL: Opened Length(mm)

Features;

- Dual distractable thoracolumbar system
- Angled inferior and superior area allow a complete contact with vertebral surface
- Composed by one piece
- Provide a secure fixation with the feature of threaded surface

ARMADA

Anterior Thoracolumbar Plate System



This implant system used with Lumbar Plate System Instrument Set
(Set Code: N-SS-014)

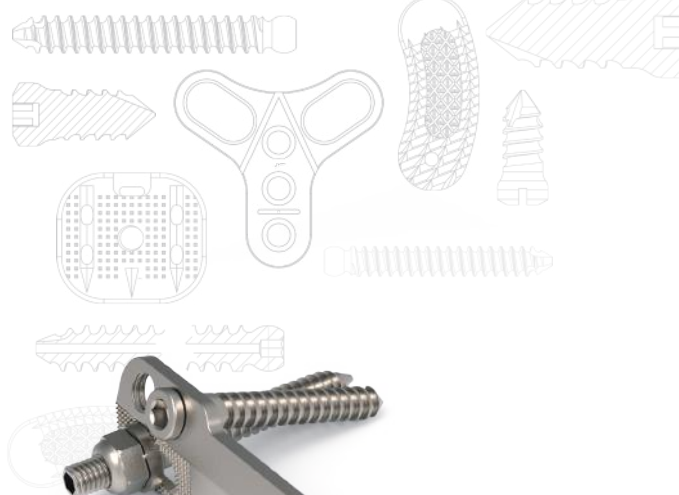

Armada Straight Locking Plate		
Product Code	Length(mm)	Piece
NSLP70U	70	<input type="checkbox"/>
NSLP80U	80	<input type="checkbox"/>
NSLP90U	90	<input type="checkbox"/>
NSLP100U	100	<input type="checkbox"/>
NSLP110U	110	<input type="checkbox"/>
NSLP120U	120	<input type="checkbox"/>



Armada Narrow Locking Plate		
Product Code	Length(mm)	Piece
NLP45U	45	<input type="checkbox"/>
NLP50U	50	<input type="checkbox"/>
NLP55U	55	<input type="checkbox"/>
NLP60U	60	<input type="checkbox"/>
NLP65U	65	<input type="checkbox"/>
NLP70U	70	<input type="checkbox"/>
NLP80U	80	<input type="checkbox"/>
NLP90U	90	<input type="checkbox"/>
NLP95U	95	<input type="checkbox"/>
NLP100U	100	<input type="checkbox"/>
NLP110U	110	<input type="checkbox"/>
NLP120U	120	<input type="checkbox"/>



Features;

- Straight Plate ,self-locking screws, nuts and washers create a rigid fixation
- Anterior Fixation for thoracolumbar vertebra

Armada Universal-Locking Screw

Product Code D(mm) L(mm) Piece

NULS7035	7.0	35	<input type="checkbox"/>
NULS7040	7.0	40	<input type="checkbox"/>
NULS7045	7.0	45	<input type="checkbox"/>
NULS7050	7.0	50	<input type="checkbox"/>
NULS7055	7.0	55	<input type="checkbox"/>



Armada Self Locking Screw

Product Code D(mm) L(mm) Piece

NSLS6020	6.0	20	<input type="checkbox"/>
NSLS6022	6.0	22	<input type="checkbox"/>
NSLS6025	6.0	25	<input type="checkbox"/>
NSLS6030	6.0	30	<input type="checkbox"/>
NSLS6035	6.0	35	<input type="checkbox"/>
NSLS6040	6.0	40	<input type="checkbox"/>
NSLS6045	6.0	45	<input type="checkbox"/>
NSLS6050	6.0	50	<input type="checkbox"/>
NSLS6055	6.0	55	<input type="checkbox"/>



Armada Cancellous Locking Screw

Product Code D(mm) L(mm) Piece

NCLS62025	6.2	25	<input type="checkbox"/>
NCLS62030	6.2	30	<input type="checkbox"/>
NCLS62035	6.2	35	<input type="checkbox"/>
NCLS62040	6.2	40	<input type="checkbox"/>

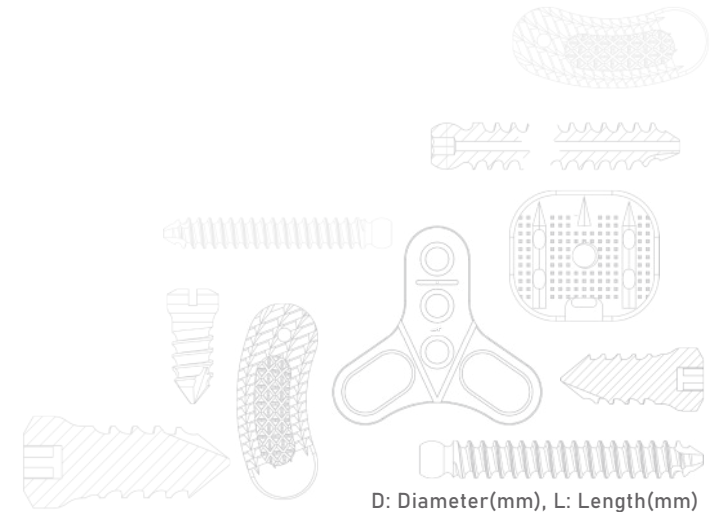

D: Diameter(mm), L: Length(mm)



This implant system used with Lumbar Plate System Instrument Set
(Set Code: N-SS-014)

ARMADA

Anterior Thoracolumbar Plate System

U-DEVICE

Interspinous Stabilisation Device



This implant system used with U-Device Instrument Set

(Set Code: N-SS-018)

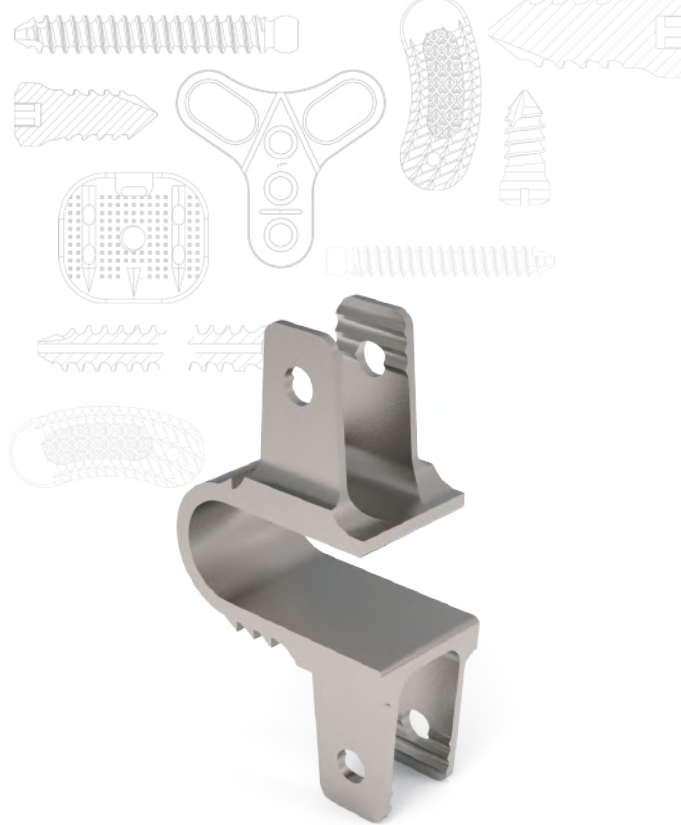

U-Device Interspinous System Stabilisation Device

Product Code	Width(mm)	Piece
NSUD-SI-08	8	
NSUD-SI-10	10	
NSUD-SI-12	12	
NSUD-SI-14	14	
NSUD-SI-16	16	

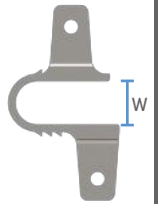

Features;

- Dynamic fixation and stabilisation.
- Reduces stresses at the facet joints
- Prevent unfolding ligamentum flavum

Twisty TLIF Peek Cage



This implant system used with Twisty TLIF Instrument Set

(Set Code: N-SS-016)

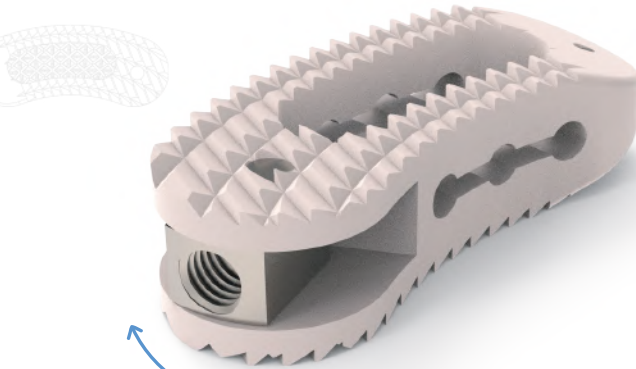
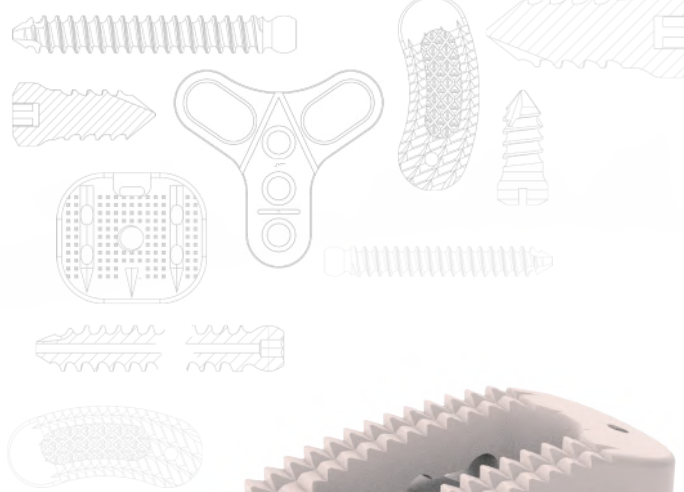

Movable titanium head

Twisty TLIF Peek Cage Product Code H(mm) L(mm) W(mm) Piece

NBC2407	7	24	10	
NBC2807	7	28	10	
NBC3207	7	32	10	
NBC2408	8	24	10	
NBC2808	8	28	10	
NBC3208	8	32	10	
NBC2409	9	24	10	
NBC2809	9	28	10	
NBC3209	9	32	10	
NBC2410	10	24	10	
NBC2810	10	28	10	
NBC3210	10	32	10	
NBC2411	11	24	10	
NBC2811	11	28	10	
NBC3211	11	32	10	
NBC2412	12	24	10	
NBC2812	12	28	10	
NBC3212	12	32	10	
NBC2413	13	24	10	
NBC2813	13	28	10	
NBC3213	13	32	10	

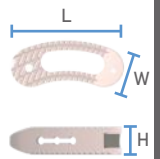

































H: Height(mm), L: Length(mm), W: Width(mm)

Features;

- The cage and the holder are initially lined up to facilitate entry
- The wedge like profile makes the cage insertion process a straight forward and easy task
- The biocompatibility and mechanical properties are perfectly suited for interbody applications
- The cage is moved to its final location with minimal effort with movable titanium part
- Allow for a higher volume of bone grafting material resulting in good fusion

Twisty TLIF Peek Cage Angled

Product Code H(mm) L(mm) W(mm) Angle Piece

NBCA24074	7	24	10	4°	
NBCA28074	7	28	10	4°	
NBCA32074	7	32	10	4°	
NBCA24084	8	24	10	4°	
NBCA24088	8	24	10	8°	
NBCA28084	8	28	10	4°	
NBCA28088	8	28	10	8°	
NBCA32084	8	32	10	4°	
NBCA32088	8	32	10	8°	
NBCA24094	9	24	10	4°	
NBCA24098	9	24	10	8°	
NBCA28094	9	28	10	4°	
NBCA28098	9	28	10	8°	
NBCA32094	9	32	10	4°	
NBCA32098	9	32	10	8°	
NBCA24104	10	24	10	4°	
NBCA24108	10	24	10	8°	
NBCA28104	10	28	10	4°	
NBCA28108	10	28	10	8°	
NBCA32104	10	32	10	4°	
NBCA32108	10	32	10	8°	
NBCA24114	11	24	10	4°	
NBCA24118	11	24	10	8°	
NBCA28114	11	28	10	4°	
NBCA28118	11	28	10	8°	
NBCA32114	11	32	10	4°	
NBCA32118	11	32	10	8°	
NBCA24124	12	24	10	4°	
NBCA24128	12	24	10	8°	
NBCA28124	12	28	10	4°	
NBCA28128	12	28	10	8°	
NBCA32124	12	32	10	4°	
NBCA32128	12	32	10	8°	







A°/2



A°/2

Twisty TLIF Peek Cage Angled

Product Code H(mm) L(mm) W(mm) Angle Piece

NBCA24134	13	24	10	4°	
NBCA24138	13	24	10	8°	
NBCA28134	13	28	10	4°	
NBCA28138	13	28	10	8°	
NBCA32134	13	32	10	4°	
NBCA32138	13	32	10	8°	

A°/2



A°/2

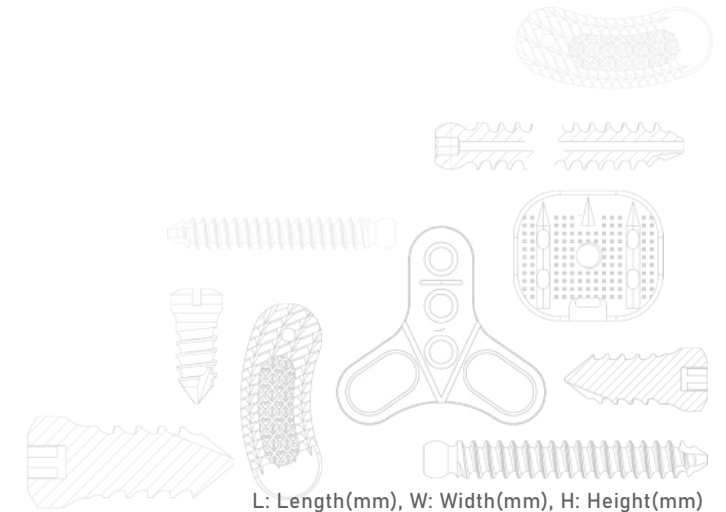

This implant system used with
Twisty TLIF Instrument Set
(Set Code: N-SS-016)

Twisty
TLIF Peek Cage

Alligator PLIF Peek Cage



This implant system used with Alligator and Alligator-Exp PLIF Instrument Set
(Set Code: N-SS-015)

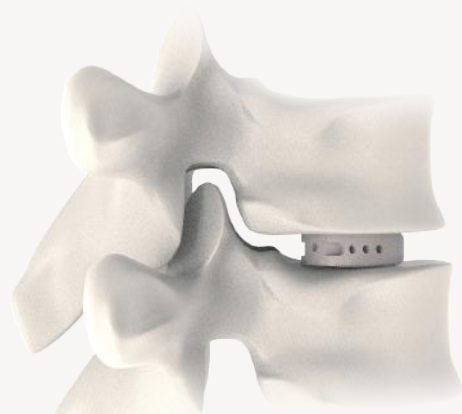
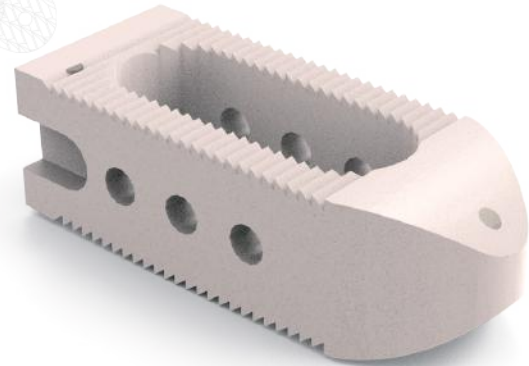
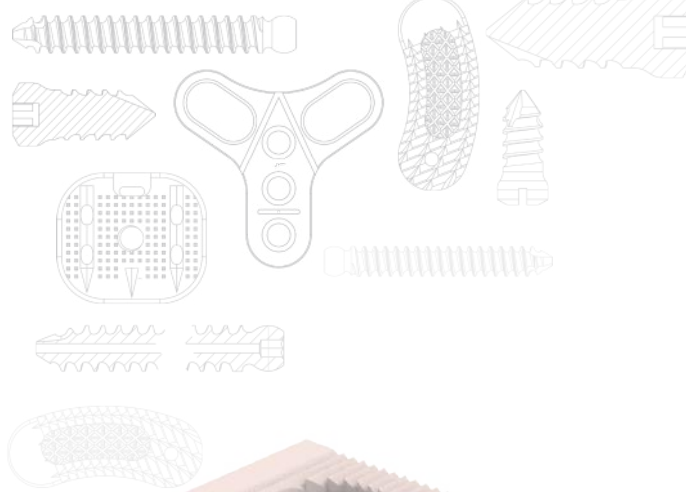

Alligator PLIF Peek Cage
Product Code H(mm) L(mm) W(mm) Piece

NVPCD2206	6	22	10	
NVPCD2406	6	24	10	
NVPCD2207	7	22	10	
NVPCD2407	7	24	10	
NVPCD2208	8	22	10	
NVPCD2408	8	24	10	
NVPCD2209	9	22	10	
NVPCD2409	9	24	10	
NVPCD2210	10	22	10	
NVPCD2410	10	24	10	
NVPCD2211	11	22	10	
NVPCD2411	11	24	10	
NVPCD2212	12	22	10	
NVPCD2412	12	24	10	

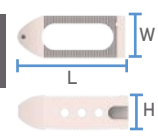

H: Height(mm), L: Length(mm), W: Width(mm)

Features;

- Tantalum marker
- Bulleted anterior profile facilitates cage insertion into the intervertebral space
- Open design of the upper and lower surfaces allows optimum graft surface to improve bone fusion

Alligator-exp PLIF Expandable Peek Cage



This implant system used with Alligator and Alligator-Exp PLIF Instrument Set
(Set Code: N-SS-015)

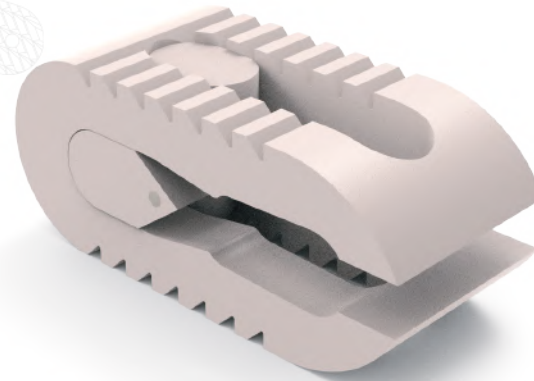
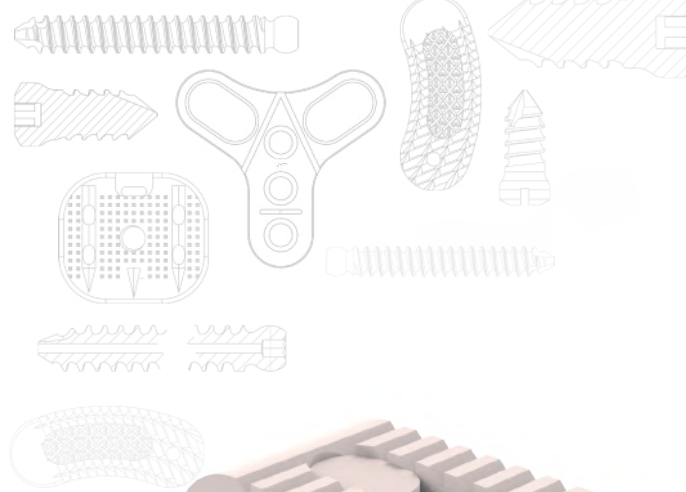

Alligator-Exp PLIF Expandable Peek Cage

Product Code H(mm) L(mm) W(mm) Piece

NEPC1007	7	24	10	
NEPC1008	8	24	10	
NEPC1009	9	24	10	
NEPC1010	10	24	10	
NEPC1011	11	24	10	
NEPC1012	12	24	10	

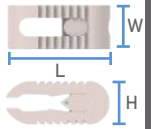

H: Height(mm), L: Length(mm), W: Width(mm)

Features;

- Don't allow any lesional problems
- Threaded surface feature facilities a strong fixation by superior and inferior area
- Height can be increased by 1 mm at least

Tra-Ti Trabecular TLIF Cage



This implant system used with **Twisty TLIF Instrument Set**

(Set Code: N-SS-016)

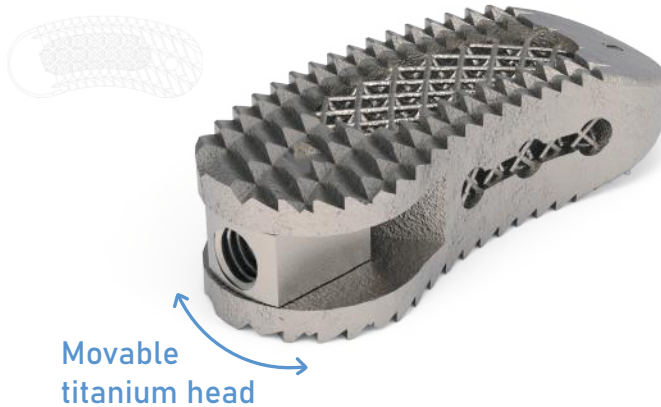
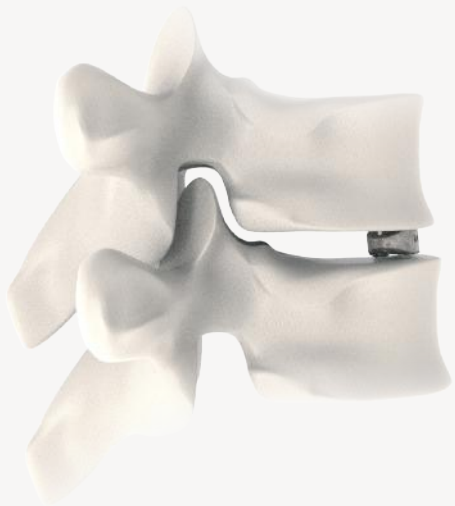

Tra-Ti Trabecular TLIF Cage

Product Code H(mm) L(mm) W(mm) Piece

N-TTT2407	7	24	10	
N-TTT2807	7	28	10	
N-TTT3207	7	32	10	
N-TTT2408	8	24	10	
N-TTT2808	8	28	10	
N-TTT3208	8	32	10	
N-TTT2409	9	24	10	
N-TTT2809	9	28	10	
N-TTT3209	9	32	10	
N-TTT2410	10	24	10	
N-TTT2810	10	28	10	
N-TTT3210	10	32	10	
N-TTT2411	11	24	10	
N-TTT2811	11	28	10	
N-TTT3211	11	32	10	
N-TTT2412	12	24	10	
N-TTT2812	12	28	10	
N-TTT3212	12	32	10	
N-TTT2413	13	24	10	
N-TTT2813	13	28	10	
N-TTT3213	13	32	10	

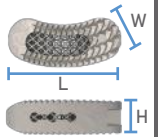

H: Height(mm), L: Length(mm), W: Width(mm)

Features;

- Smooth wedge nose to facilitate insertion
- Solid-tipped, precisely angled serrations on the superior and inferior surfaces designed for bidirectional fixation and to maximize surface area for endplate contact with the implant

Tra-Ti Trabecular TLIF Cage Angled

Product Code H(mm) L(mm) W(mm) Angle Piece

N-TTTA24074	7	24	10	4°	<input type="checkbox"/>
N-TTTA28074	7	28	10	4°	<input type="checkbox"/>
N-TTTA32074	7	32	10	4°	<input type="checkbox"/>
N-TTTA24084	8	24	10	4°	<input type="checkbox"/>
N-TTTA24088	8	24	10	8°	<input type="checkbox"/>
N-TTTA28084	8	28	10	4°	<input type="checkbox"/>
N-TTTA28088	8	28	10	8°	<input type="checkbox"/>
N-TTTA32084	8	32	10	4°	<input type="checkbox"/>
N-TTTA32088	8	32	10	8°	<input type="checkbox"/>
N-TTTA24094	9	24	10	4°	<input type="checkbox"/>
N-TTTA24098	9	24	10	8°	<input type="checkbox"/>
N-TTTA28094	9	28	10	4°	<input type="checkbox"/>
N-TTTA28098	9	28	10	8°	<input type="checkbox"/>
N-TTTA32094	9	32	10	4°	<input type="checkbox"/>
N-TTTA32098	9	32	10	8°	<input type="checkbox"/>
N-TTTA24104	10	24	10	4°	<input type="checkbox"/>
N-TTTA24108	10	24	10	8°	<input type="checkbox"/>
N-TTTA28104	10	28	10	4°	<input type="checkbox"/>
N-TTTA28108	10	28	10	8°	<input type="checkbox"/>
N-TTTA32104	10	32	10	4°	<input type="checkbox"/>
N-TTTA32108	10	32	10	8°	<input type="checkbox"/>
N-TTTA24114	11	24	10	4°	<input type="checkbox"/>
N-TTTA24118	11	24	10	8°	<input type="checkbox"/>
N-TTTA28114	11	28	10	4°	<input type="checkbox"/>
N-TTTA28118	11	28	10	8°	<input type="checkbox"/>
N-TTTA32114	11	32	10	4°	<input type="checkbox"/>
N-TTTA32118	11	32	10	8°	<input type="checkbox"/>
N-TTTA24124	12	24	10	4°	<input type="checkbox"/>
N-TTTA24128	12	24	10	8°	<input type="checkbox"/>
N-TTTA28124	12	28	10	4°	<input type="checkbox"/>
N-TTTA28128	12	28	10	8°	<input type="checkbox"/>
N-TTTA32124	12	32	10	4°	<input type="checkbox"/>
N-TTTA32128	12	32	10	8°	<input type="checkbox"/>

A°/2



A°/2

Tra-Ti Trabecular TLIF Cage Angled

Product Code H(mm) L(mm) W(mm) Angle Piece

N-TTTA24134	13	24	10	4°	<input type="checkbox"/>
N-TTTA24138	13	24	10	8°	<input type="checkbox"/>
N-TTTA28134	13	28	10	4°	<input type="checkbox"/>
N-TTTA28138	13	28	10	8°	<input type="checkbox"/>
N-TTTA32134	13	32	10	4°	<input type="checkbox"/>
N-TTTA32138	13	32	10	8°	<input type="checkbox"/>

A°/2



A°/2



This implant system used with
Twisty TLIF Instrument Set
(Set Code: N-SS-016)

Twisty
TLIF Peek Cage

Tra-Ti Trabecular PLIF Cage



This implant system used with Alligator and Alligator-Exp PLIF Instrument Set
(Set Code: N-SS-015)

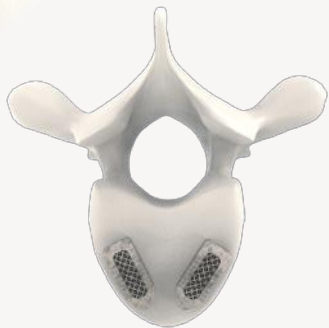
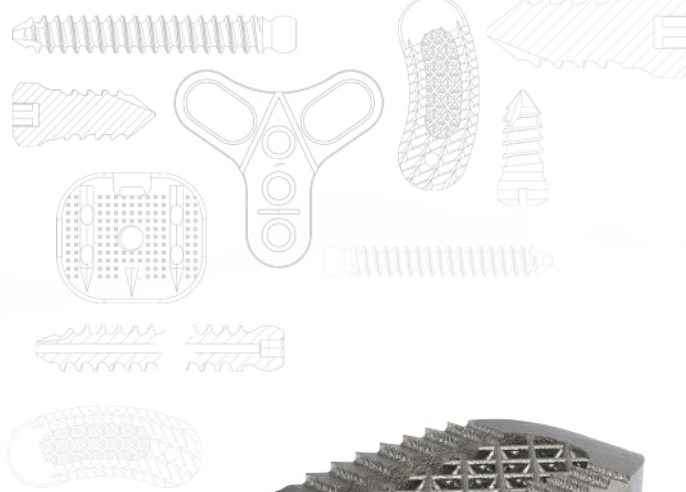

Tra-Ti Trabecular PLIF Cage
Product Code H(mm) L(mm) W(mm) Piece

N-TTP2407	7	24	10	
N-TTP2807	7	28	10	
N-TTP3207	7	32	10	
N-TTP2408	8	24	10	
N-TTP2808	8	28	10	
N-TTP3208	8	32	10	
N-TTP2409	9	24	10	
N-TTP2809	9	28	10	
N-TTP3209	9	32	10	
N-TTP2410	10	24	10	
N-TTP2810	10	28	10	
N-TTP3210	10	32	10	
N-TTP2411	11	24	10	
N-TTP2811	11	28	10	
N-TTP3211	11	32	10	
N-TTP2412	12	24	10	
N-TTP2812	12	28	10	
N-TTP3212	12	32	10	
N-TTP2413	13	24	10	
N-TTP2813	13	28	10	
N-TTP3213	13	32	10	

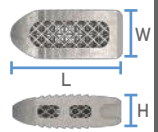

H: Height(mm), L: Length(mm), W: Width(mm)

Features;

- Anatomical surface
- Smooth wedge nose to facilitate insertion
- Highly porous titanium alloy on top and bottom of implant and all sides of internal graft window

ESA ALIF Peek Cage



This implant system used with ALIF Peek Cage Instrument Set
(Set Code: N-SS-023)

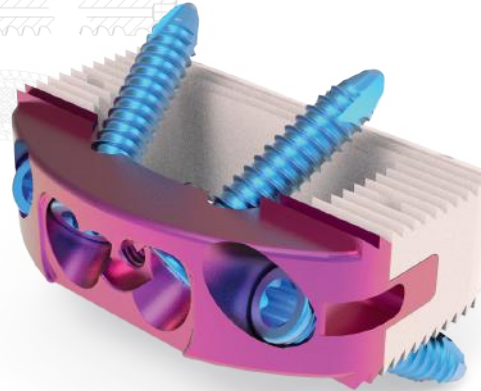
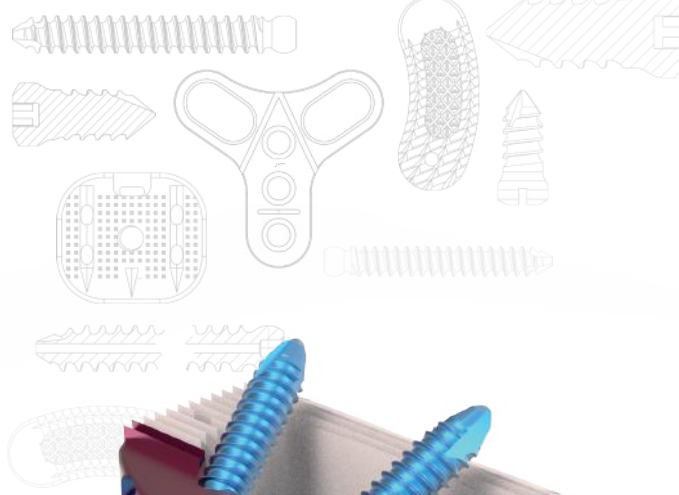

Product Code	H(mm)	L(mm)	W(mm)	Angle	Piece
NALC25351004	10	25	35	4°	
NALC25351009	10	25	35	9°	
NALC25351014	10	25	35	14°	
NALC29401004	10	29	40	4°	
NALC29401009	10	29	40	9°	
NALC29401014	10	29	40	14°	
NALC25351204	12	25	35	4°	
NALC25351209	12	25	35	9°	
NALC25351214	12	25	35	14°	
NALC29401204	12	29	40	4°	
NALC29401209	12	29	40	9°	
NALC29401214	12	29	40	14°	
NALC25351404	14	25	35	4°	
NALC25351409	14	25	35	9°	
NALC25351414	14	25	35	14°	
NALC29401404	14	29	40	4°	
NALC29401409	14	29	40	9°	
NALC29401414	14	29	40	14°	
NALC25351604	16	25	35	4°	
NALC25351609	16	25	35	9°	
NALC25351614	16	25	35	14°	
NALC29401604	16	29	40	4°	
NALC29401609	16	29	40	9°	
NALC29401614	16	29	40	14°	

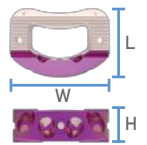

L: Length(mm), W: Width(mm), H: Height(mm)

Features;

- Full contact, full fusion through unique movable head technology
- Fit with the anatomy of patient
- Adjustable easily with threaded mechanism
- Adjustable easily with threaded surface

ESA Alif Peek Cage

Product Code H(mm) L(mm) W(mm) Angle Piece

NALC25351804	18	25	35	4°	<input type="checkbox"/>
NALC25351809	18	25	35	9°	<input type="checkbox"/>
NALC25351814	18	25	35	14°	<input type="checkbox"/>
NALC29401804	18	29	40	4°	<input type="checkbox"/>
NALC29401809	18	29	40	9°	<input type="checkbox"/>
NALC29401814	18	29	40	14°	<input type="checkbox"/>
NALC25352004	20	25	35	4°	<input type="checkbox"/>
NALC25352009	20	25	35	9°	<input type="checkbox"/>
NALC25352014	20	25	35	14°	<input type="checkbox"/>
NALC29402004	20	29	40	4°	<input type="checkbox"/>
NALC29402009	20	29	40	9°	<input type="checkbox"/>
NALC29402014	20	29	40	14°	<input type="checkbox"/>

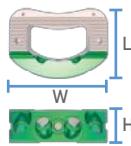

ESA Alif Screw

Product Code Diameter(mm) Length(mm) Piece

NALCS4020	4.0	20	<input type="checkbox"/>
NALCS4025	4.0	25	<input type="checkbox"/>
NALCS4030	4.0	30	<input type="checkbox"/>
NALCS4320	4.3	20	<input type="checkbox"/>
NALCS4325	4.3	25	<input type="checkbox"/>
NALCS4330	4.3	30	<input type="checkbox"/>
NALCSF4020	4.0	20	<input type="checkbox"/>
NALCSF4025	4.0	25	<input type="checkbox"/>
NALCSF4030	4.0	30	<input type="checkbox"/>
NALCSF4320	4.3	20	<input type="checkbox"/>
NALCSF4325	4.3	25	<input type="checkbox"/>
NALCSF4330	4.3	30	<input type="checkbox"/>

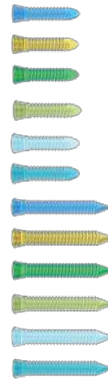

Fine Type



Blunt Type

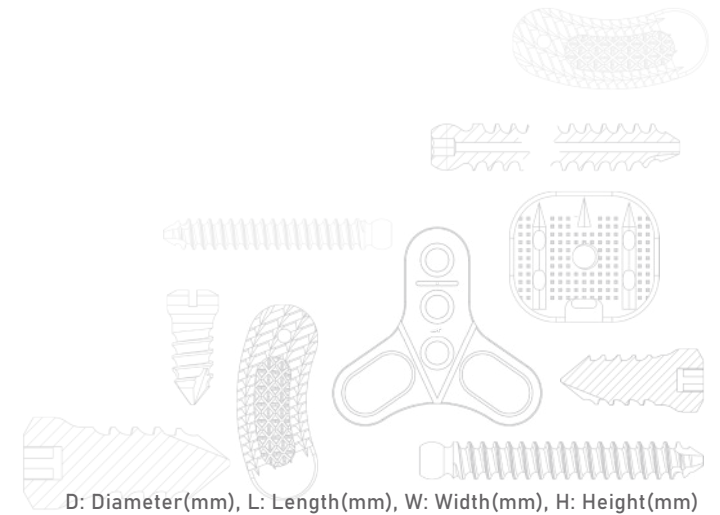

D: Diameter(mm), L: Length(mm), W: Width(mm), H: Height(mm)



This implant system used with
ALIF Peek Cage Instrument Set
(Set Code: N-SS-023)

ESA
ALIF Peek Cage

TOWERfix

Scoliosis Deformity Instrument Set



Tower Fix Scoliosis Deformity Instrument Set used with thoracolumbar screws

(Set Code: N-SS-002)

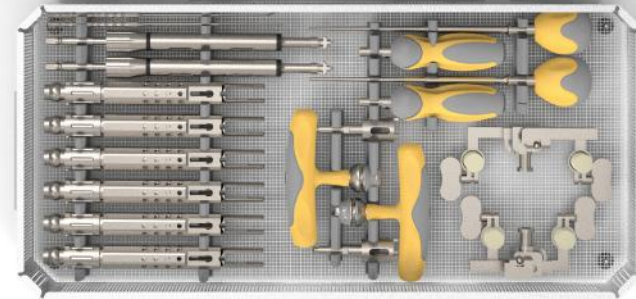
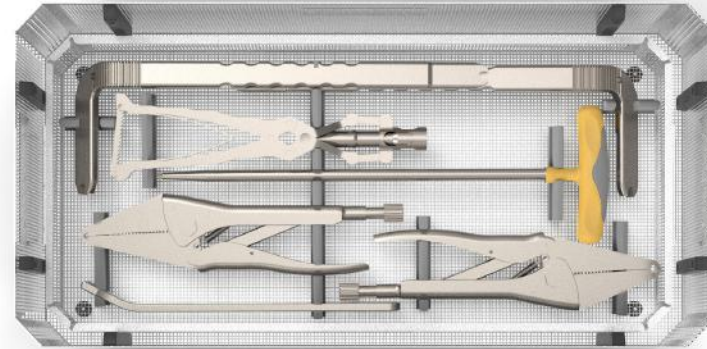
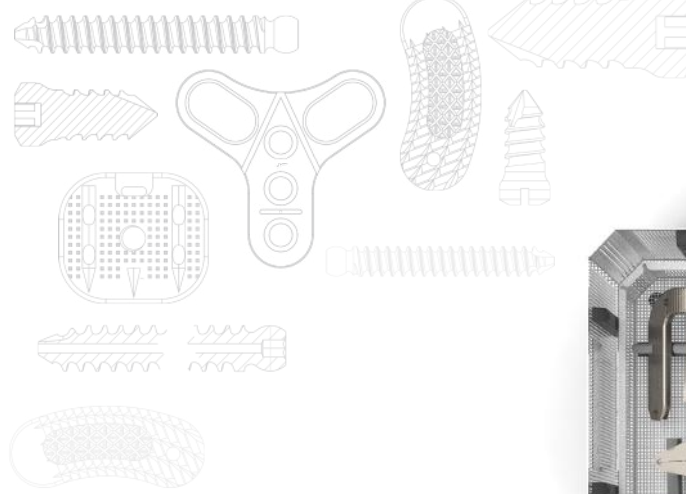

Features;

- The Towerfix Deformity Correction System offers even greater options for surgeons treating patients with spinal deformity. When surgically treating a variety of thoracolumbar pathologies, the Towerfix Deformity Correction System offers additional implant and instrument options to the Towerfix Spinal Fixation System needed to perform complex spine procedures.

Osteotomy & Curette System



Osteotomy Instrument Set
used with **Plexus & Silver**
Posterior Spinal Instrument
Set

(Set Code: N-SS-003, Set Code: N-SS-001)

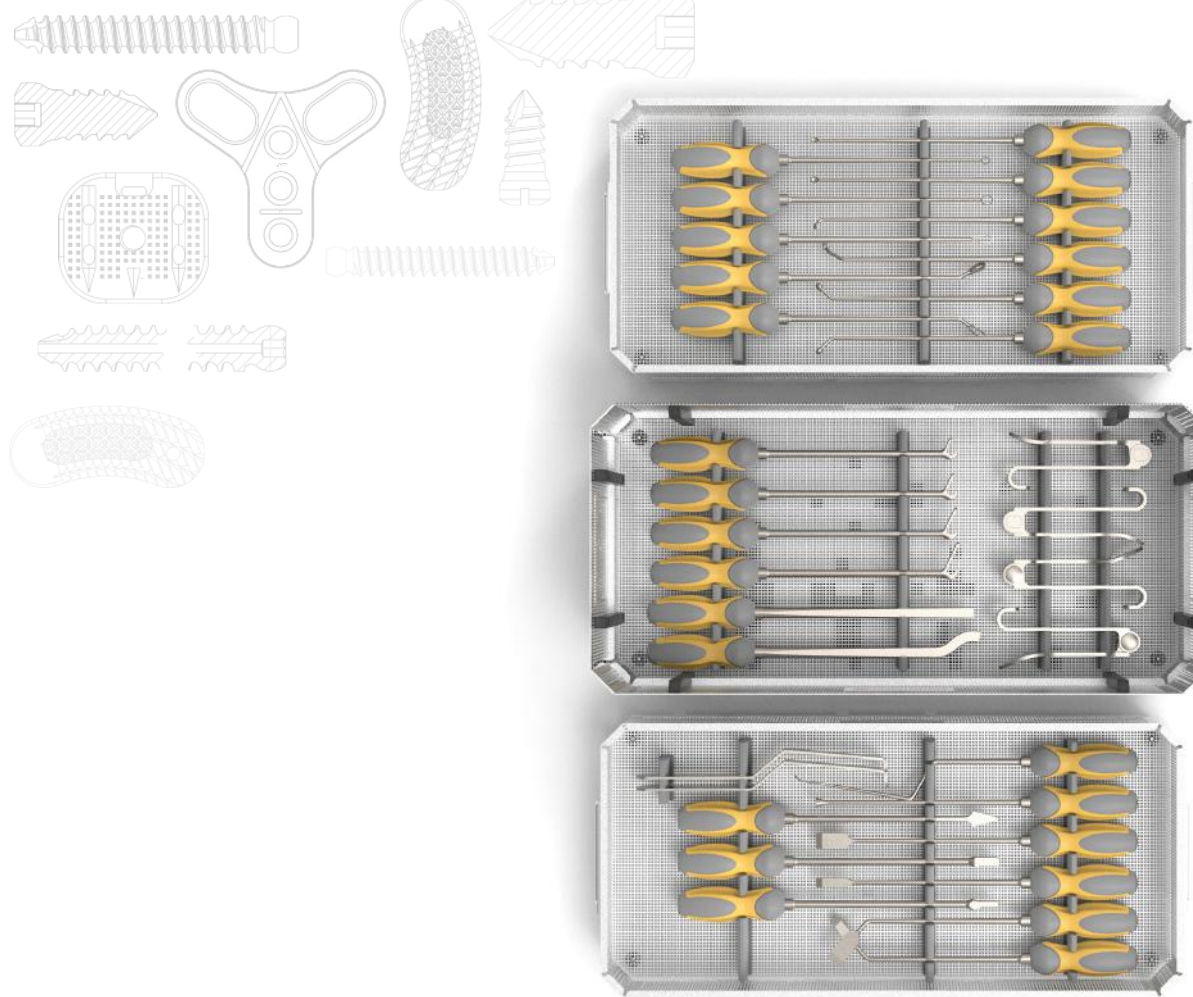
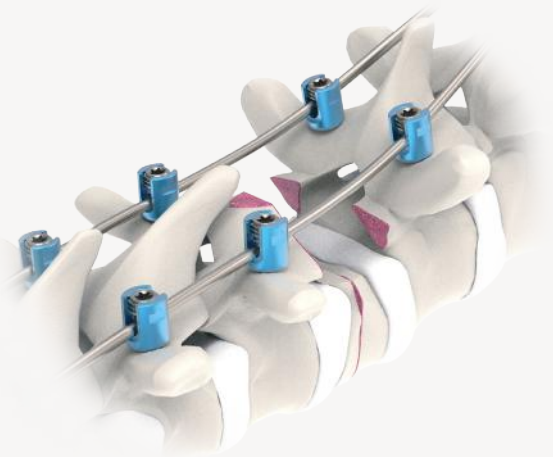

Features;

- Provide effective and simple use
- Include a wide selection of specialized instrumentation
- A truly complete set with dedicated instruments for corrective osteotomies
- Accommodate surgical preferences and anatomical variations
- Soft tissue retraction and protection

Nova-Reinforce

Kyphoplasty Vertebroplasty System

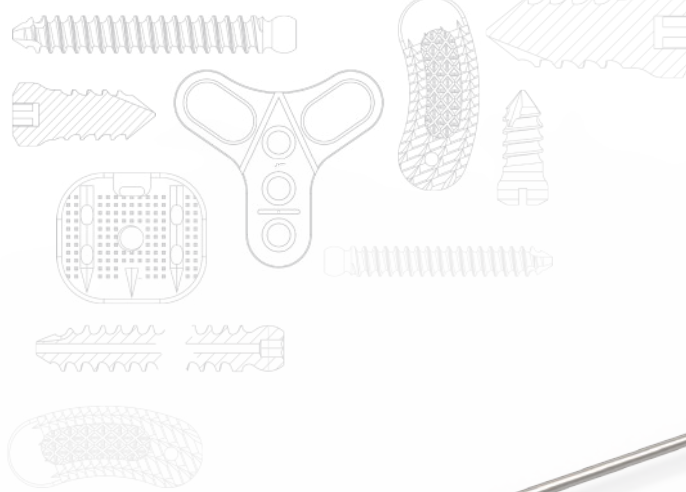

Features;

- Kyphoplasty is a minimally invasive surgery used to treat a spinal compression fracture
- Reduce pain from the fracture
- Stabilize the vertebra
- Restore the vertebra back to its normal height with balloon system

Spinal Bone Cement



This graft materials are used with **Vertebroplasty System**

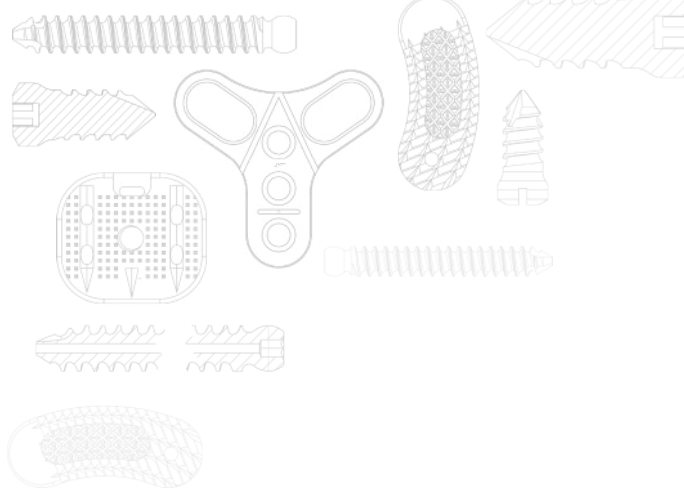

Spinal Bone Cement		
Product Code	Weight(gram)	Piece
NBES-20	20	<input type="checkbox"/>
NBES-40	40	<input type="checkbox"/>
NBES-60	60	<input type="checkbox"/>

Spinal High Viscosity Bone Cement		
Product Code	Weight(gram)	Piece
NHV-20	20	<input type="checkbox"/>
NHV-40	40	<input type="checkbox"/>
NHV-60	60	<input type="checkbox"/>

Spinal Low Viscosity Bone Cement		
Product Code	Weight(gram)	Piece
NLV-20	20	<input type="checkbox"/>
NLV-40	40	<input type="checkbox"/>
NLV-60	60	<input type="checkbox"/>

Features;

- An ideal bone graft substitute should be biomechanically stable, able to degrade within an appropriate time frame, exhibit osteoconductive, osteogenic and osteoinductive properties and provide a favourable environment for invading blood vessels and bone forming cells.



Instrument Sets

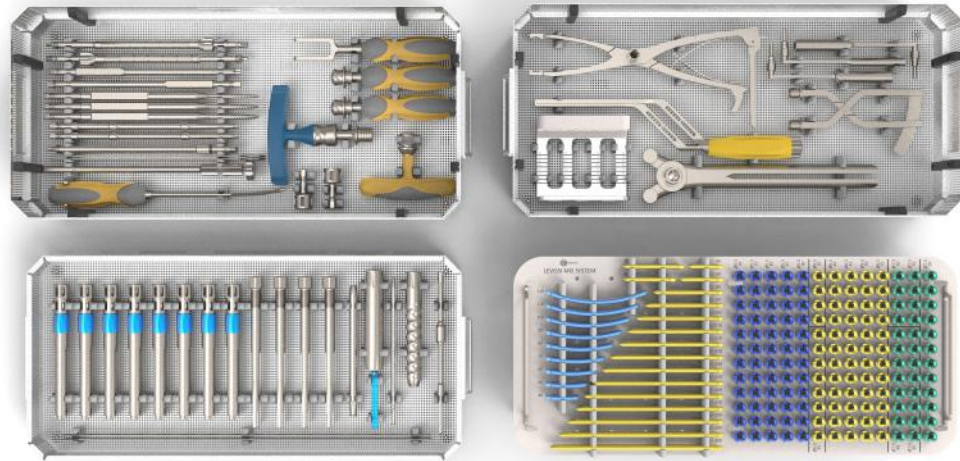

Polar and Polar-B Cervical Peek Cage Instrument Set

(Set Code: N-SS-013)



This container is made of wiremesh stainless steel. It has a high stability, low weight and good sterilization feature.

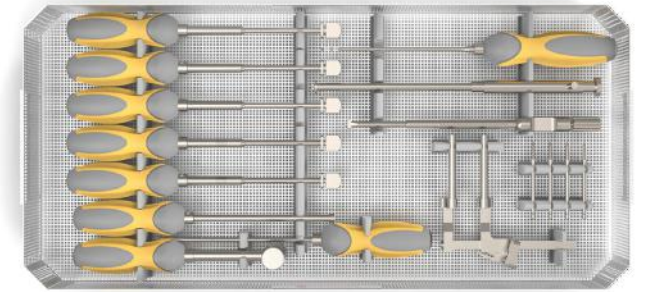

Trimi Anterior Cervical Plate Instrument Set

(Set Code: N-SS-024)



This container is made of wiremesh stainless steel. It has a high stability, low weight and good sterilization feature.

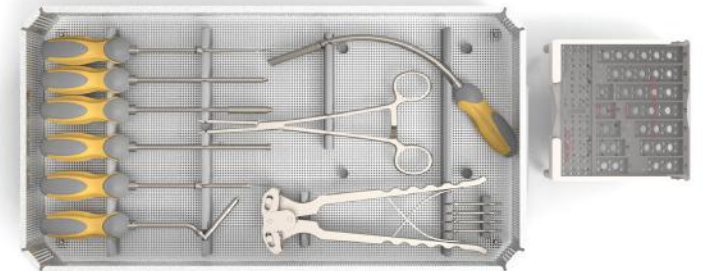
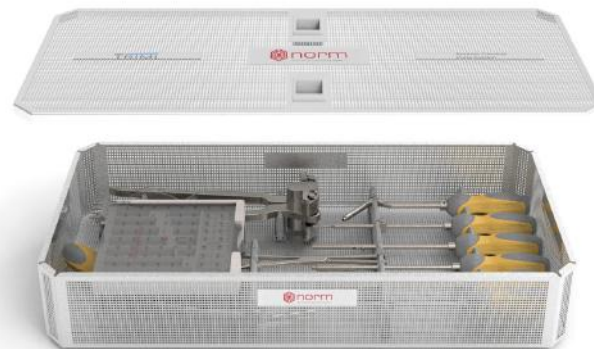

Vertelift-C Corpectomy Cage Instrument Set

(Set Code: N-SS-006)



This container is made of wiremesh stainless steel. It has a high stability, low weight and good sterilization feature.

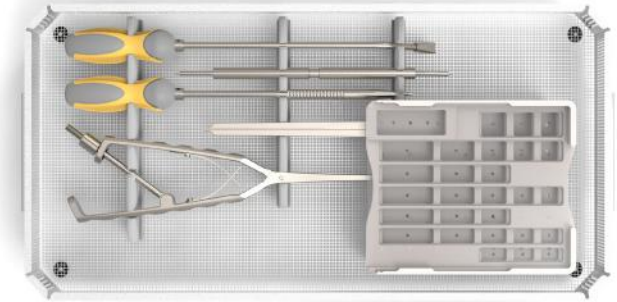
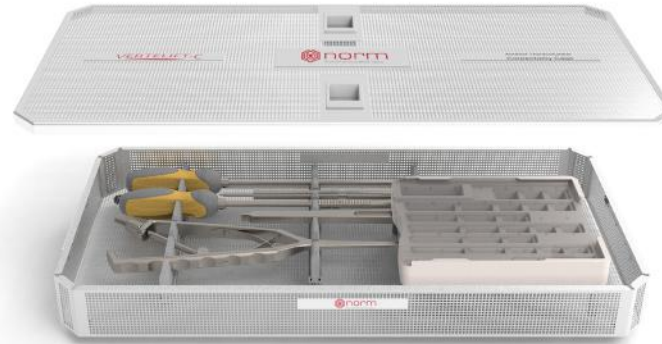

Laminoplasty Plate Instrument Set

(Set Code: N-SS-019)



This container is made of wiremesh stainless steel. It has a high stability, low weight and good sterilization feature.

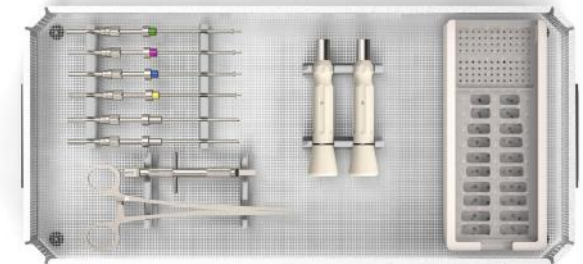
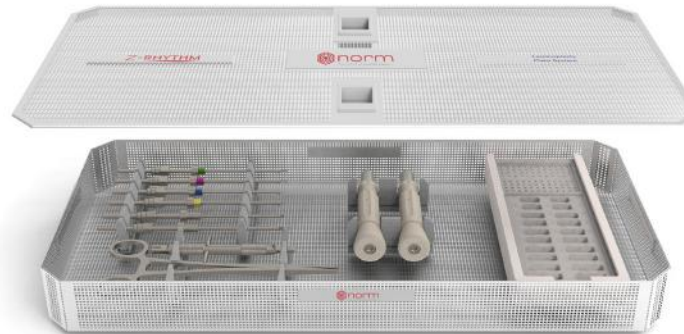

Oxis-PLUS Instrument Set

(Set Code: N-SS-005)



This container is made of wiremesh stainless steel. It has a high stability, low weight and good sterilization feature.

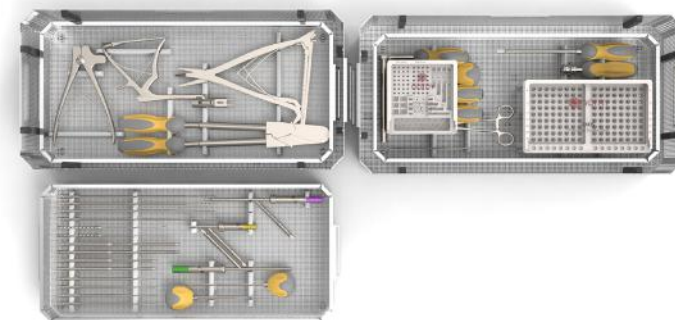

Cervical Disc Prosthesis Instrument Set

(Set Code: N-SS-021)



This container is made of wiremesh stainless steel. It has a high stability, low weight and good sterilization feature.

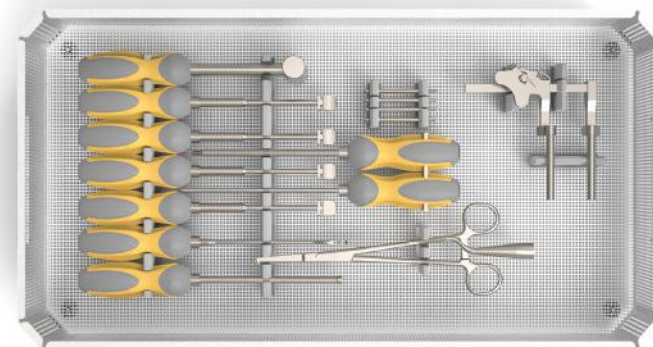

Plexus & Silver Posterior Spinal Instrument Set

(Set Code: N-SS-001)



This container is made of wiremesh stainless steel. It has a high stability, low weight and good sterilization feature.

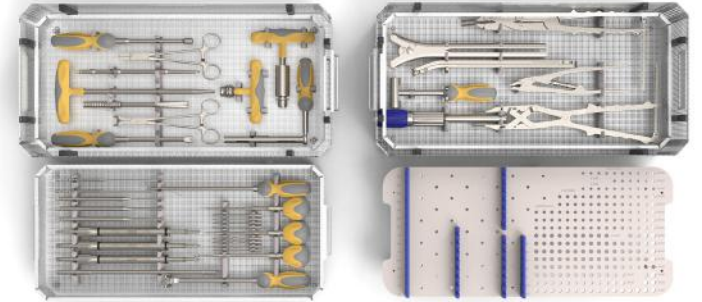

Levissi MIS Screw System Instrument Set

(Set Code: N-SS-004)



This container is made of wiremesh stainless steel. It has a high stability, low weight and good sterilization feature.

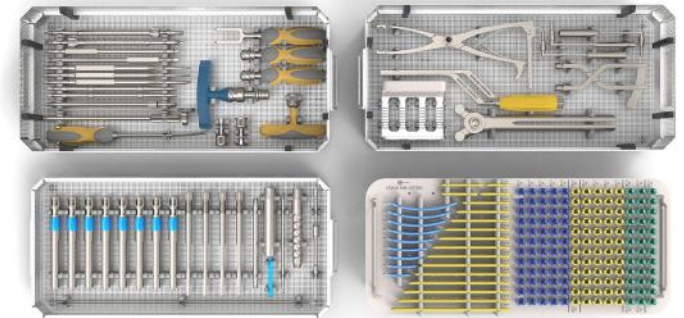
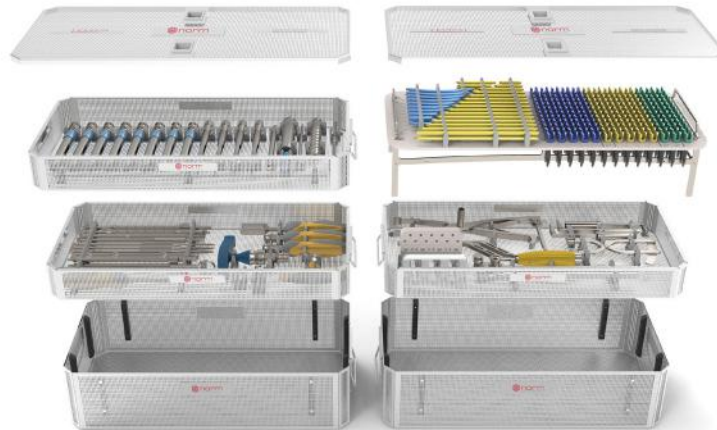

Tower Fix Scoliosis Deformity Instrument Set

(Set Code: N-SS-002)



This container is made of wiremesh stainless steel. It has a high stability, low weight and good sterilization feature.

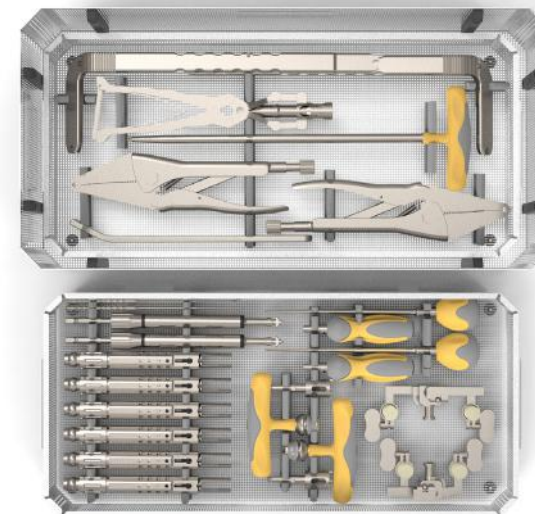

Pedifix Instrument Set

(Set Code: N-SS-020)



This container is made of wiremesh stainless steel. It has a high stability, low weight and good sterilization feature.

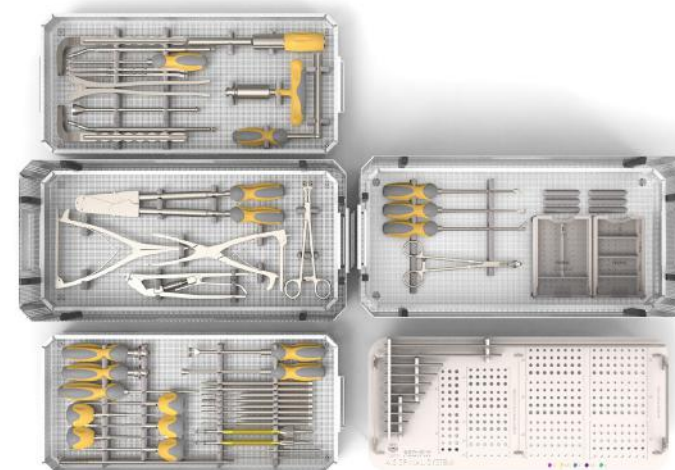

Vertelift - T Instrument Set

(Set Code: N-SS-007)



This container is made of wiremesh stainless steel. It has a high stability, low weight and good sterilization feature.

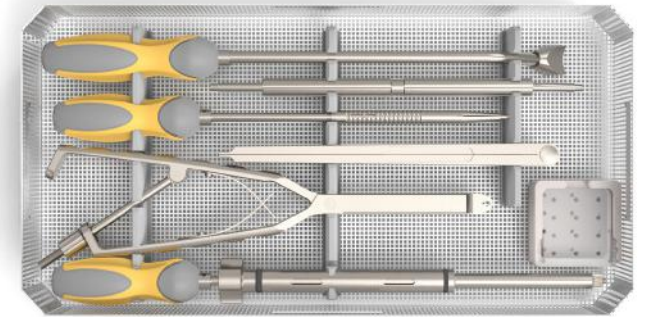
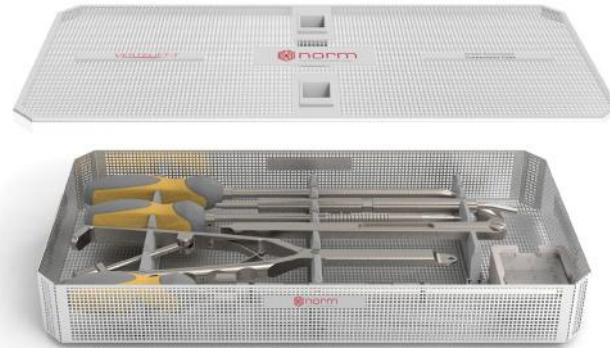

Lumbar Plate System Instrument Set

(Set Code: N-SS-014)



This container is made of wiremesh stainless steel. It has a high stability, low weight and good sterilization feature.

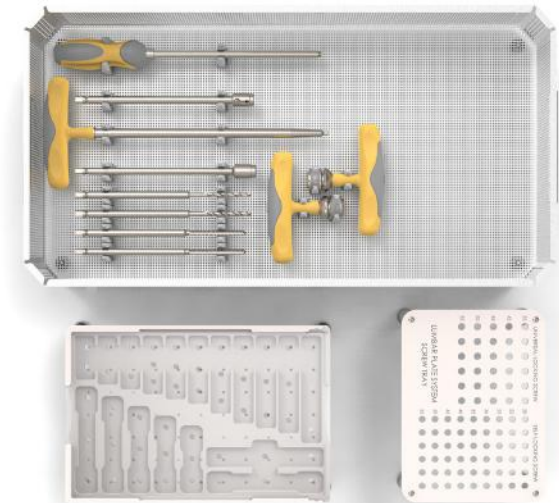
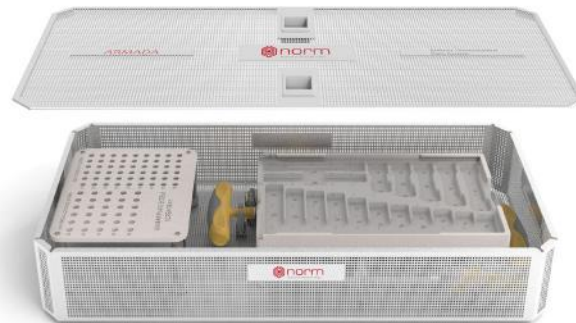

U-Device Instrument Set

(Set Code: N-SS-018)



This container is made of wiremesh stainless steel. It has a high stability, low weight and good sterilization feature.

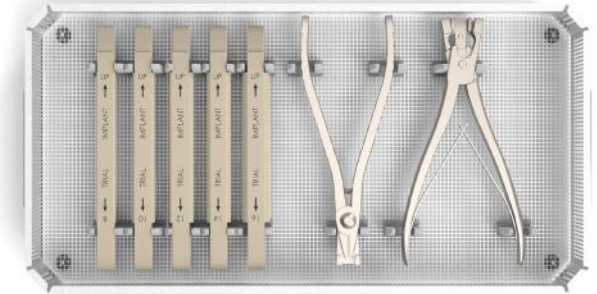

Twisty TLIF Instrument Set

(Set Code: N-SS-016)



This container is made of wiremesh stainless steel. It has a high stability, low weight and good sterilization feature.

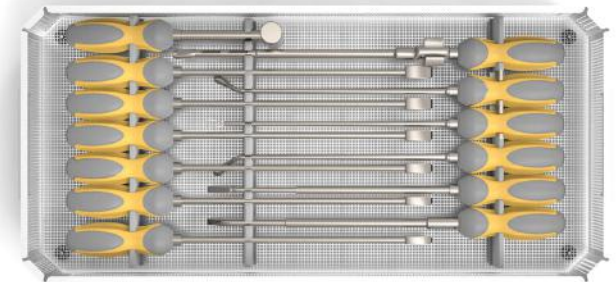

Alligator and Alligator-Exp PLIF Instrument Set

(Set Code: N-SS-015)



This container is made of wiremesh stainless steel. It has a high stability, low weight and good sterilization feature.

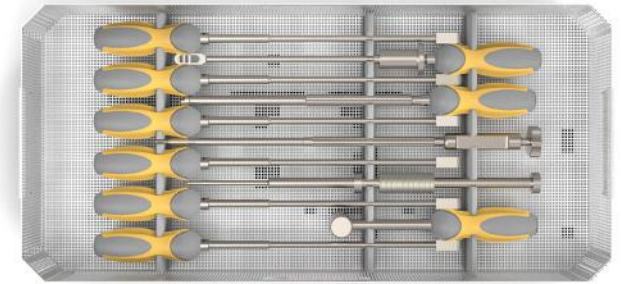

ALIF Peek Cage Instrument Set

(Set Code: N-SS-023)



This container is made of wiremesh stainless steel. It has a high stability, low weight and good sterilization feature.

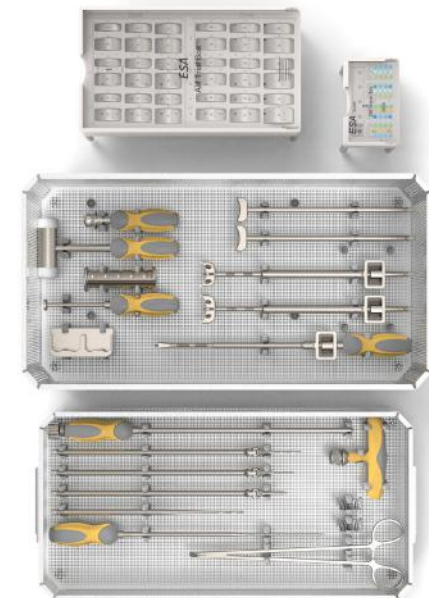

Osteotomy Instrument Set

(Set Code: N-SS-003)



This container is made of wiremesh stainless steel. It has a high stability, low weight and good sterilization feature.

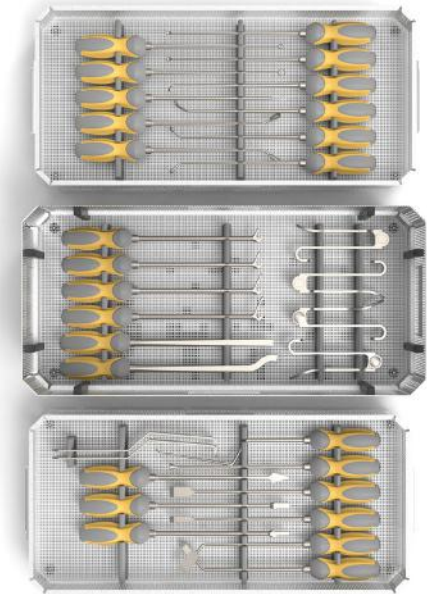

Plexus Hook System Instrument Set

(Set Code: N-SS-022)



This container is made of wiremesh stainless steel. It has a high stability, low weight and good sterilization feature.

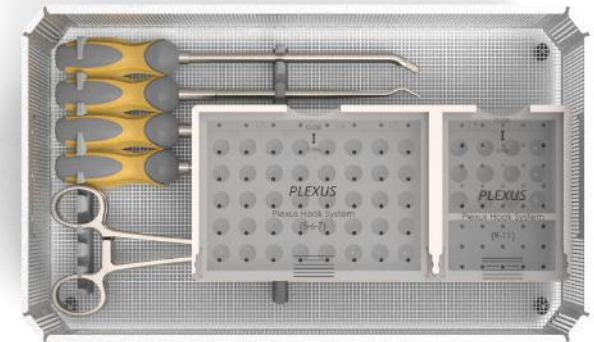
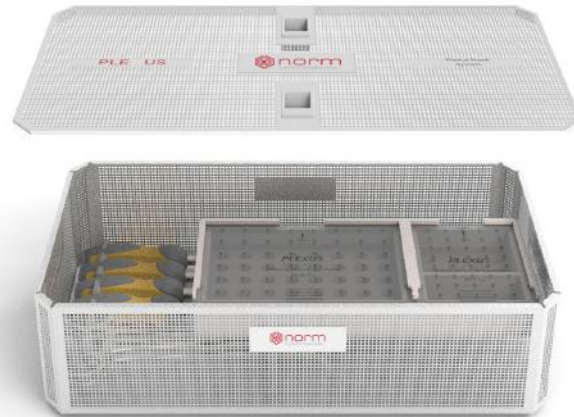

Cervical Retractor System Instrument Set

(Set Code: N-SS-010)



This container is made of wiremesh stainless steel. It has a high stability, low weight and good sterilization feature.

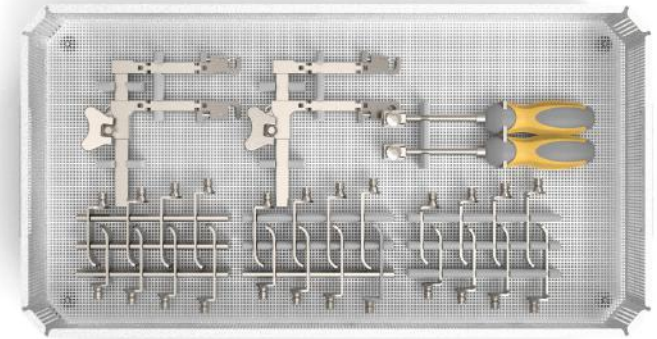
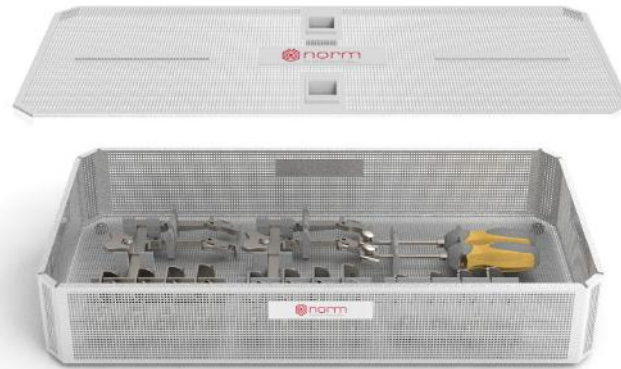



Norm Tıbbi Ürünler İth. İhr. San. ve Tic. Ltd. Şti.
İvedik O.S.B. 1468 Cad. No: 193
Yenimahalle / ANKARA / TÜRKİYE

T : +90 312 284 00 80
F : +90 312 285 30 93
info@normltd.net
www.normltd.net
